

Behind the Scenes of the



Badge

by Joe Grand
aka Kingpin

Me .



electrical engineer.

hardware hacker.

product designer.



Retrospective: DEFCON 14

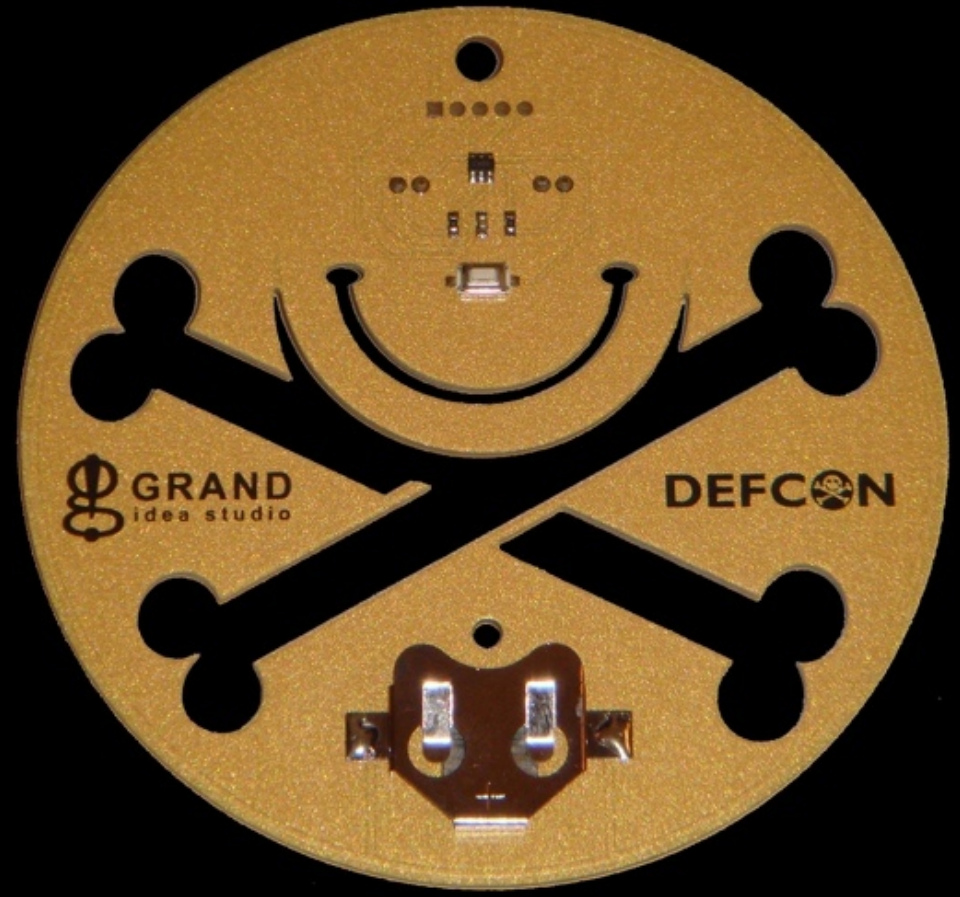

Retrospective: DEFCON 15



Retrospective: DEFCON 15



Retrospective: DEFCON 16

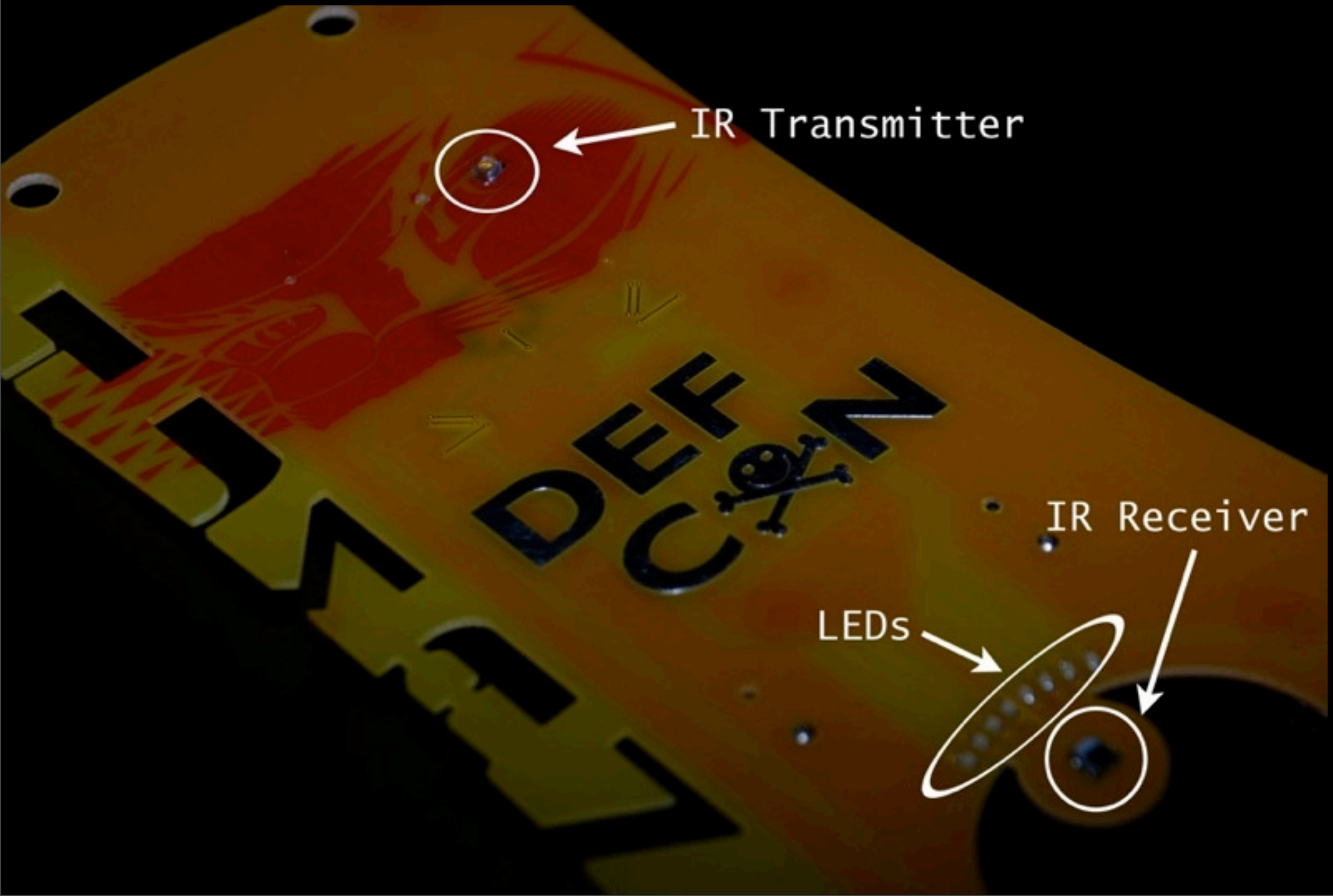

Retrospective: DEFCOM 16

SecureDigital socket

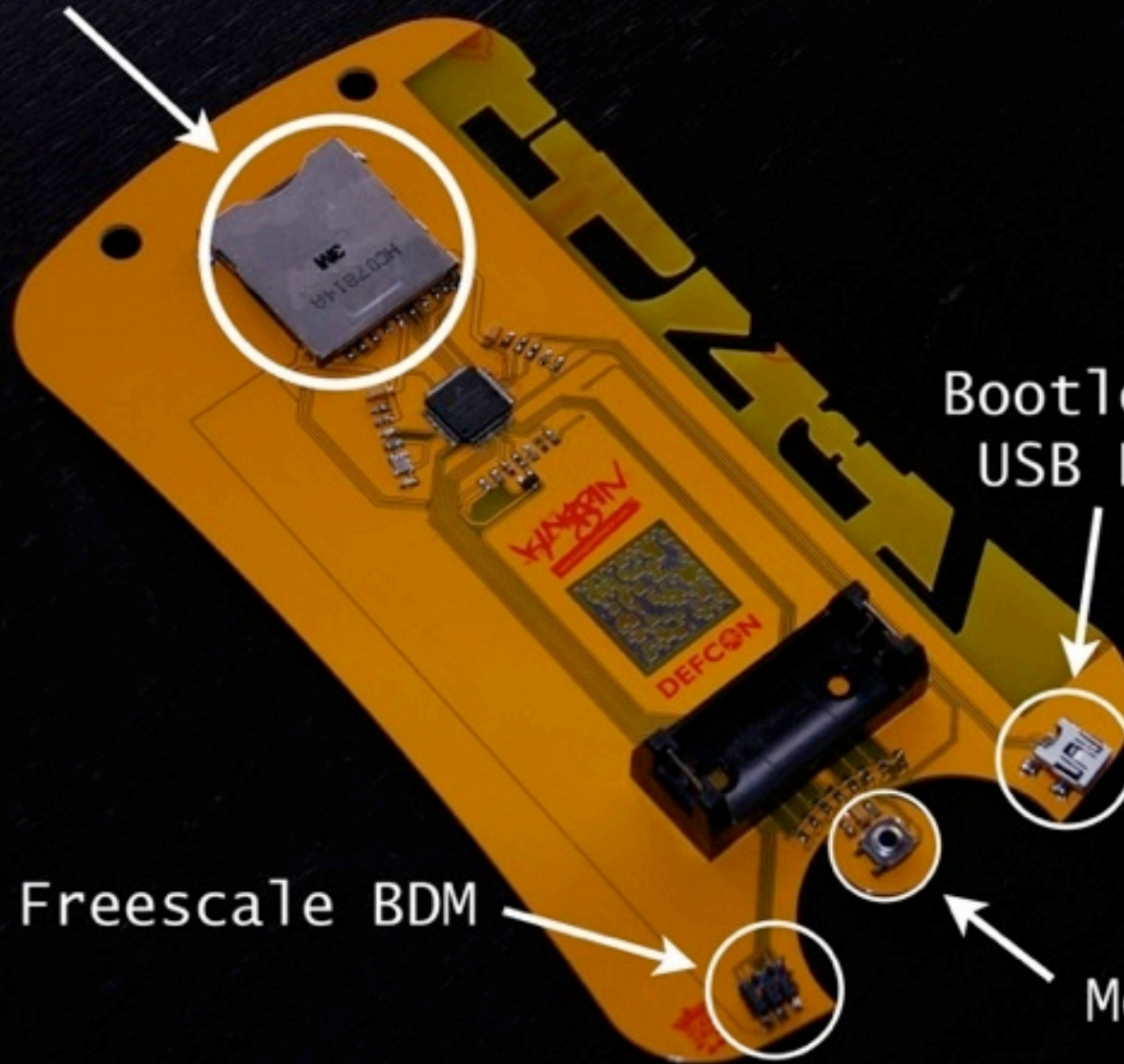

BootLoader/
USB Debug

Freescale BDM

Mode Select
Switch



Retrospective: DEFCON 17

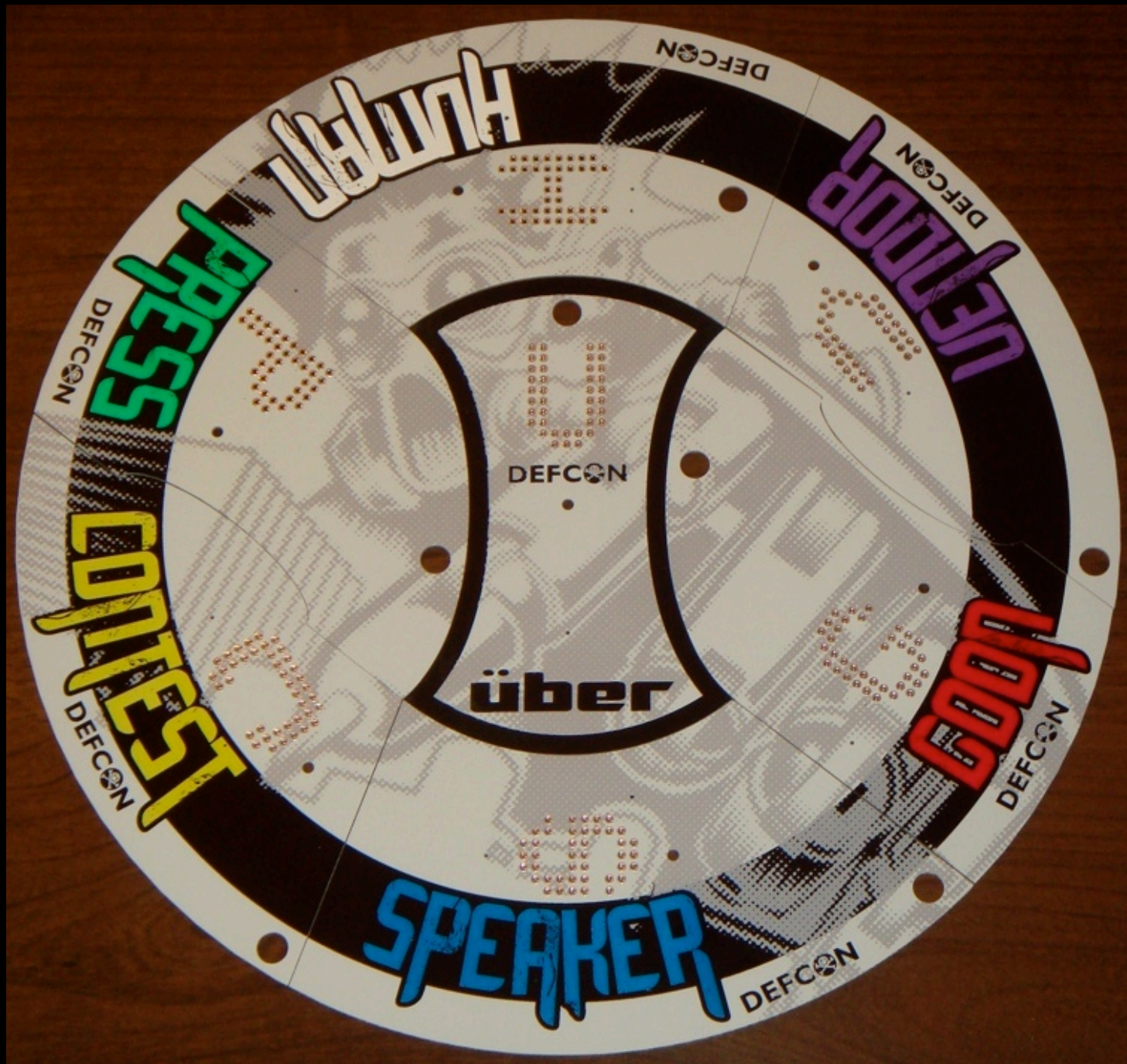

Retrospective: DEFCOM 17

Freescale DSC
& Testpoints

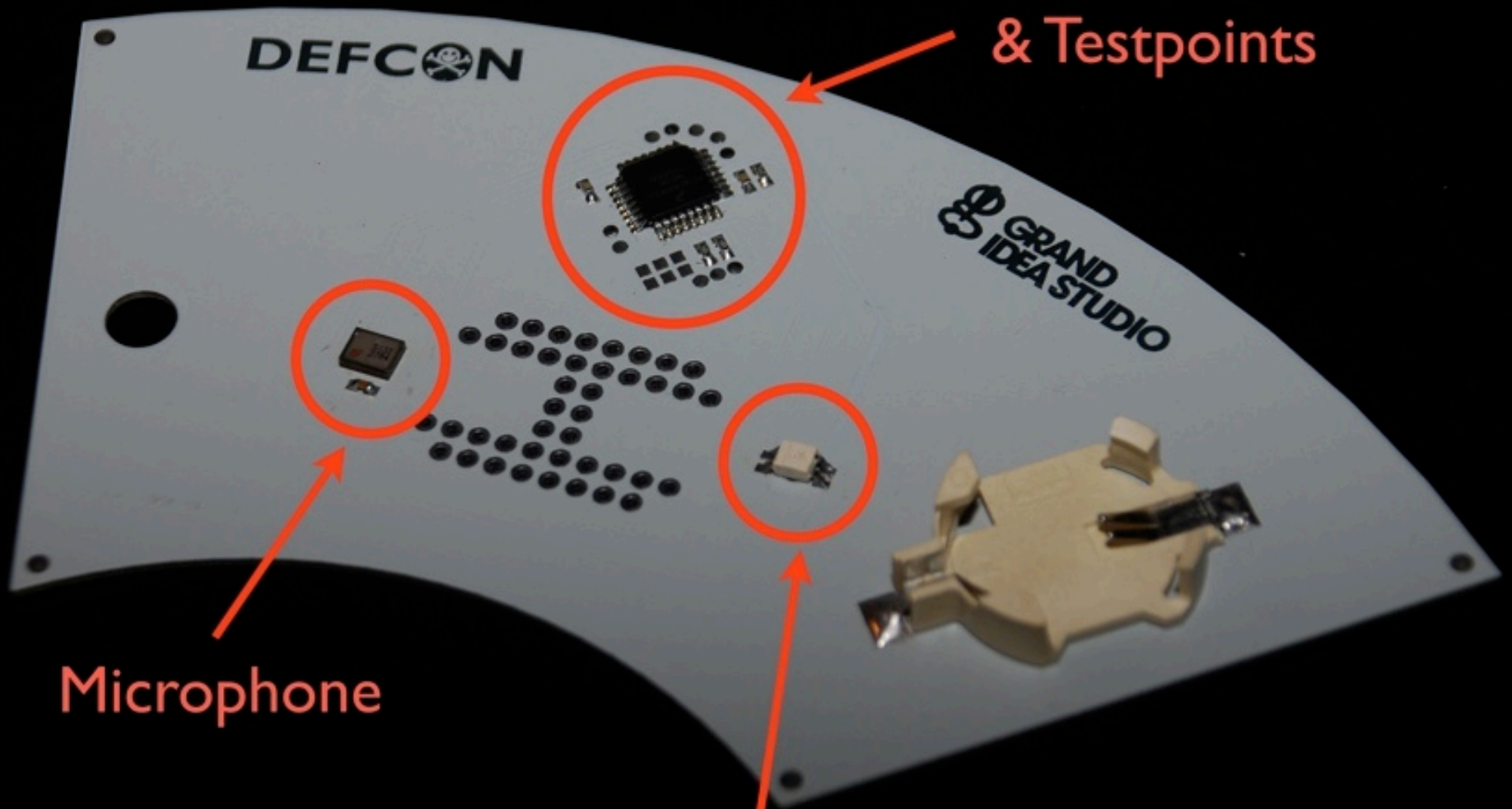

Microphone

RGB LED



Badges by Christmas?



Timeline

Yeah right!

- ★ Fall 2009: Initial brainstorming (DT, Black Beetle, Neil)
- ★ January 2010: Preliminary design & parts selection
- ★ January: Prototype hardware design
- ★ February: Low-level firmware completed
- ★ February: Production design finalized
- ★ March: Production component orders
- ★ April-May: Finish firmware
- ★ June: Program microcontrollers (Avnet)
- ★ June-July: Badge fabrication, assembly & test (e-Teknet)
- ★ July: Badges shipped to DEFCON (on time!)



The Development Process Picture Show

Original sketch

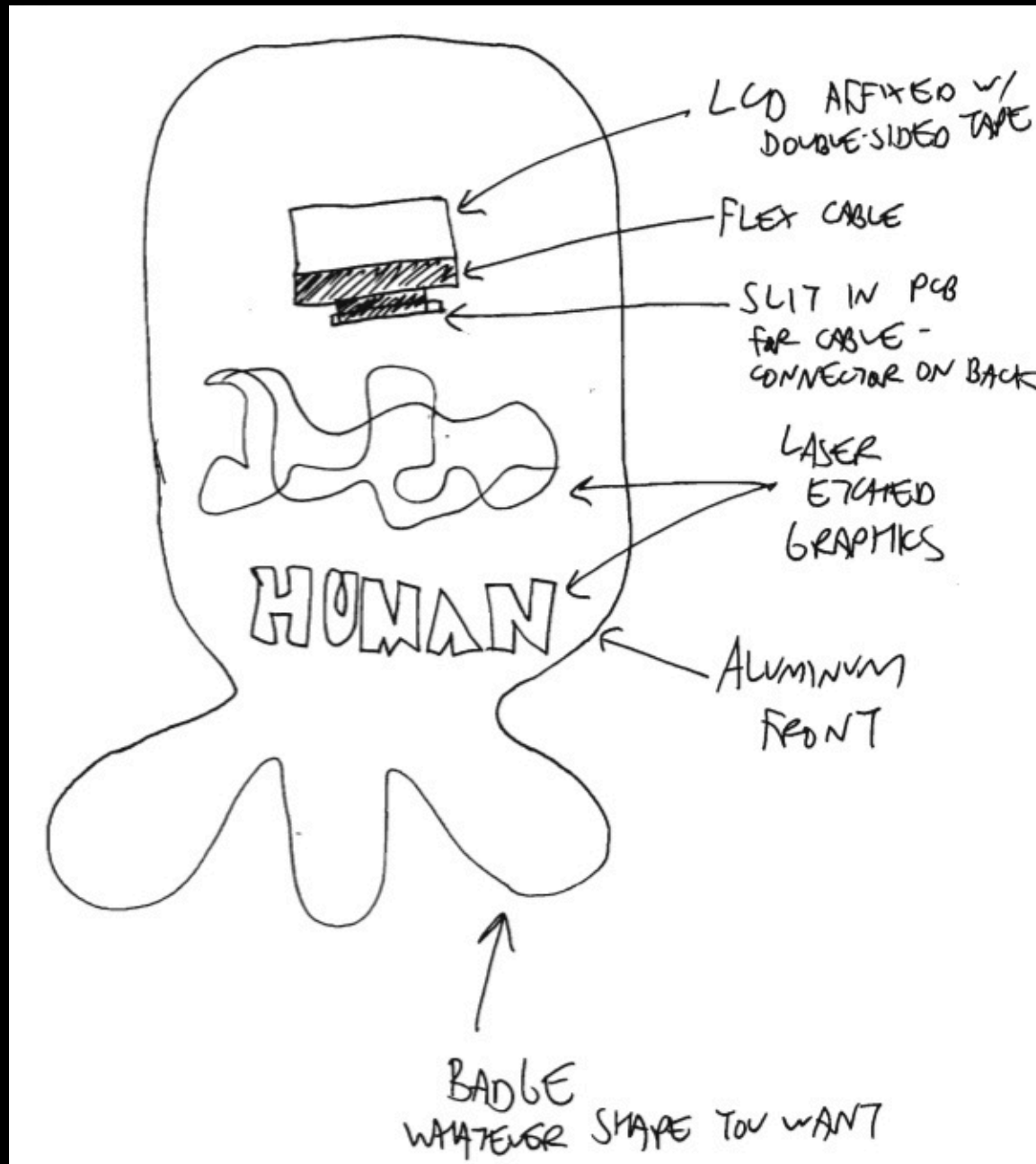

The Development Process Picture Show 2

Paper mock-up

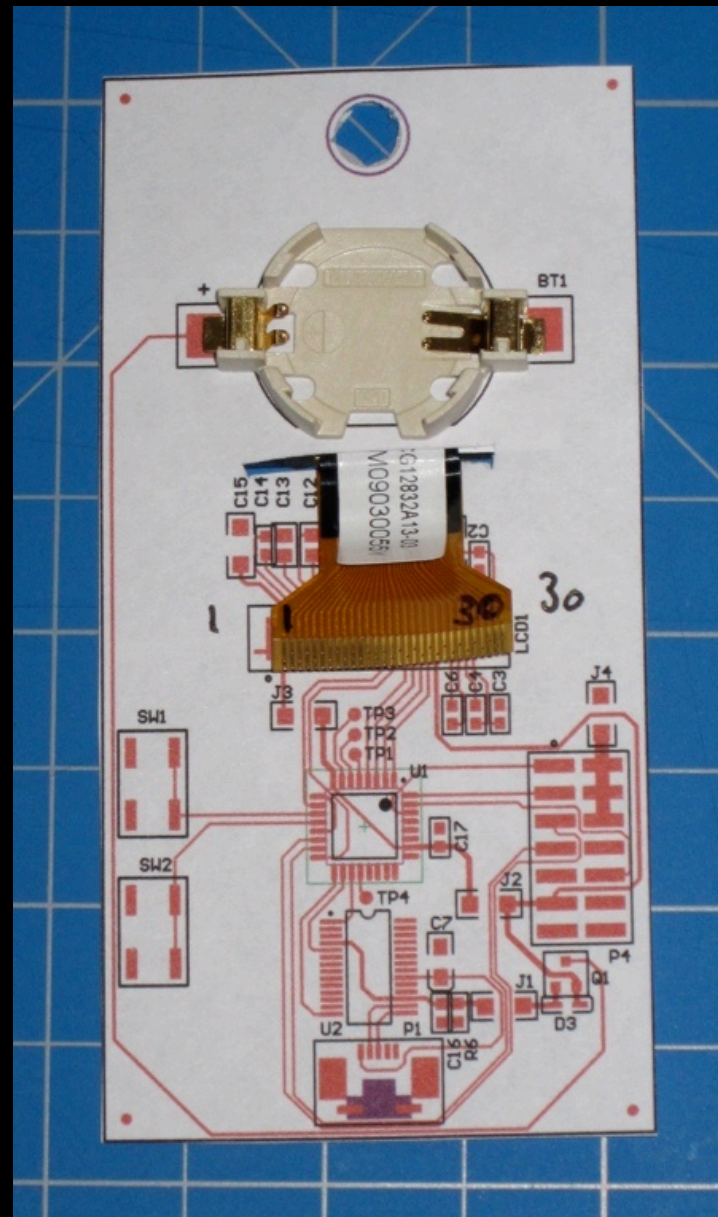
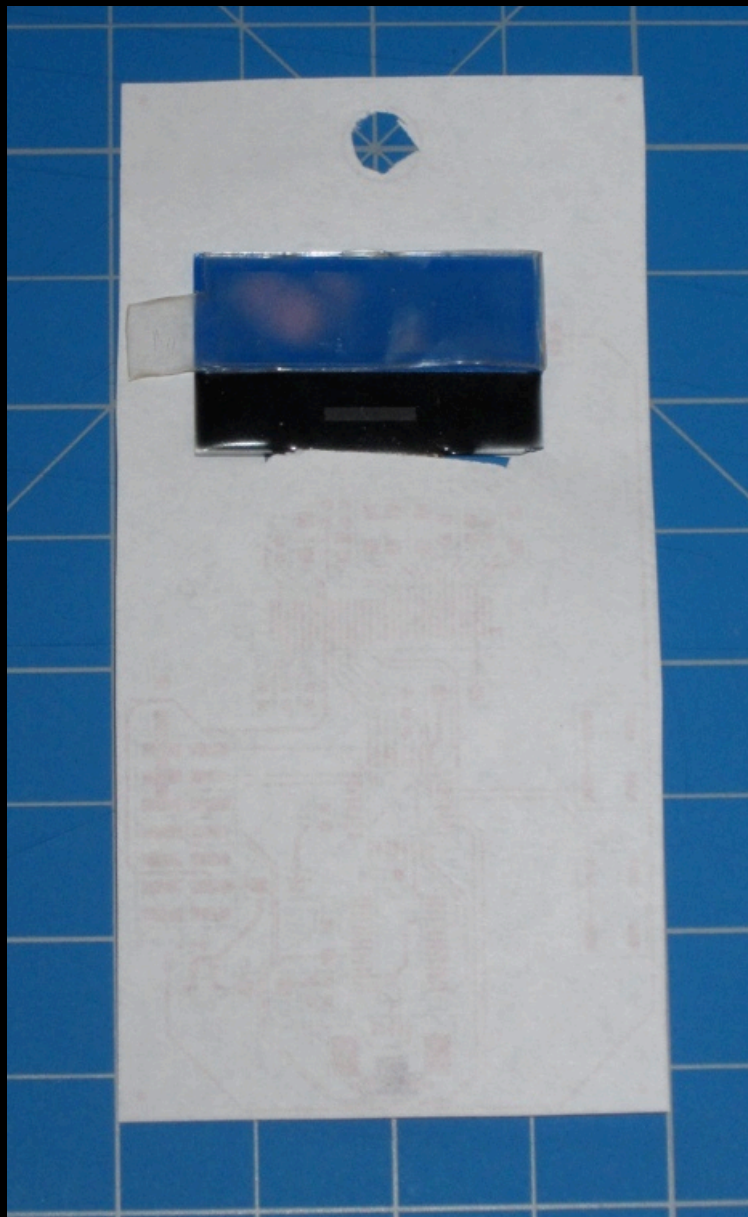

The Development Process Picture Show 3

Prototype hardware

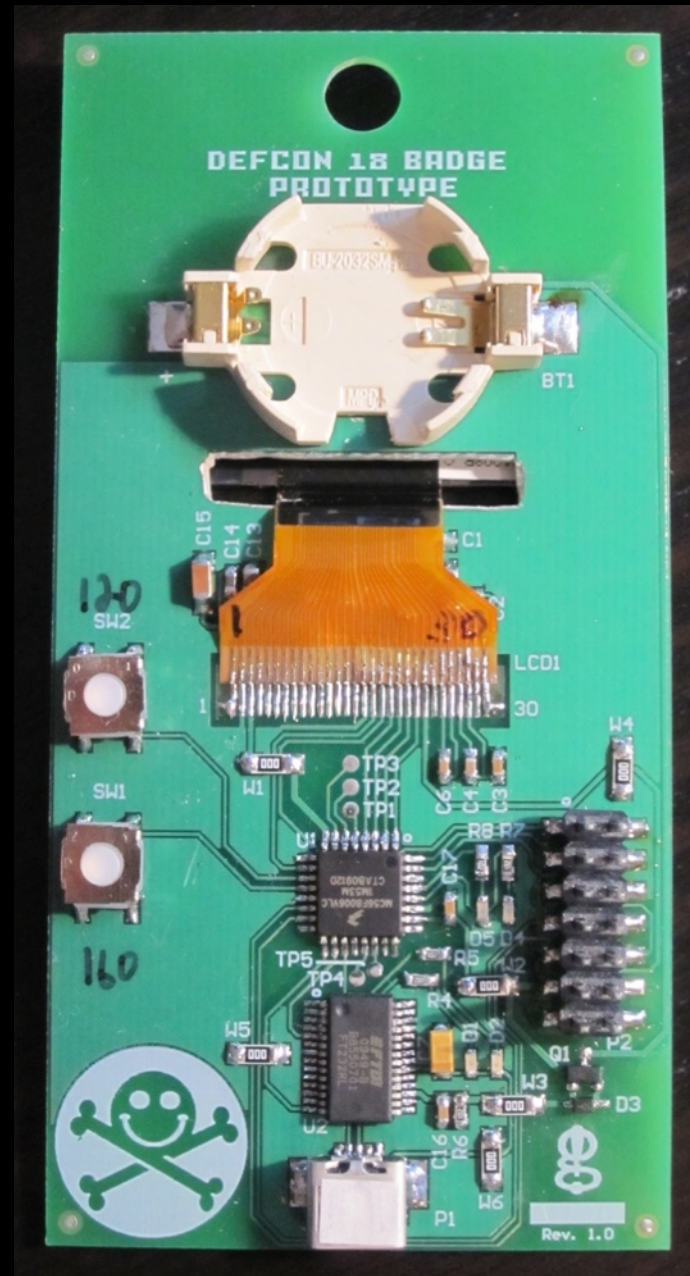

The Development Process

Picture Show 4

Testing hardware

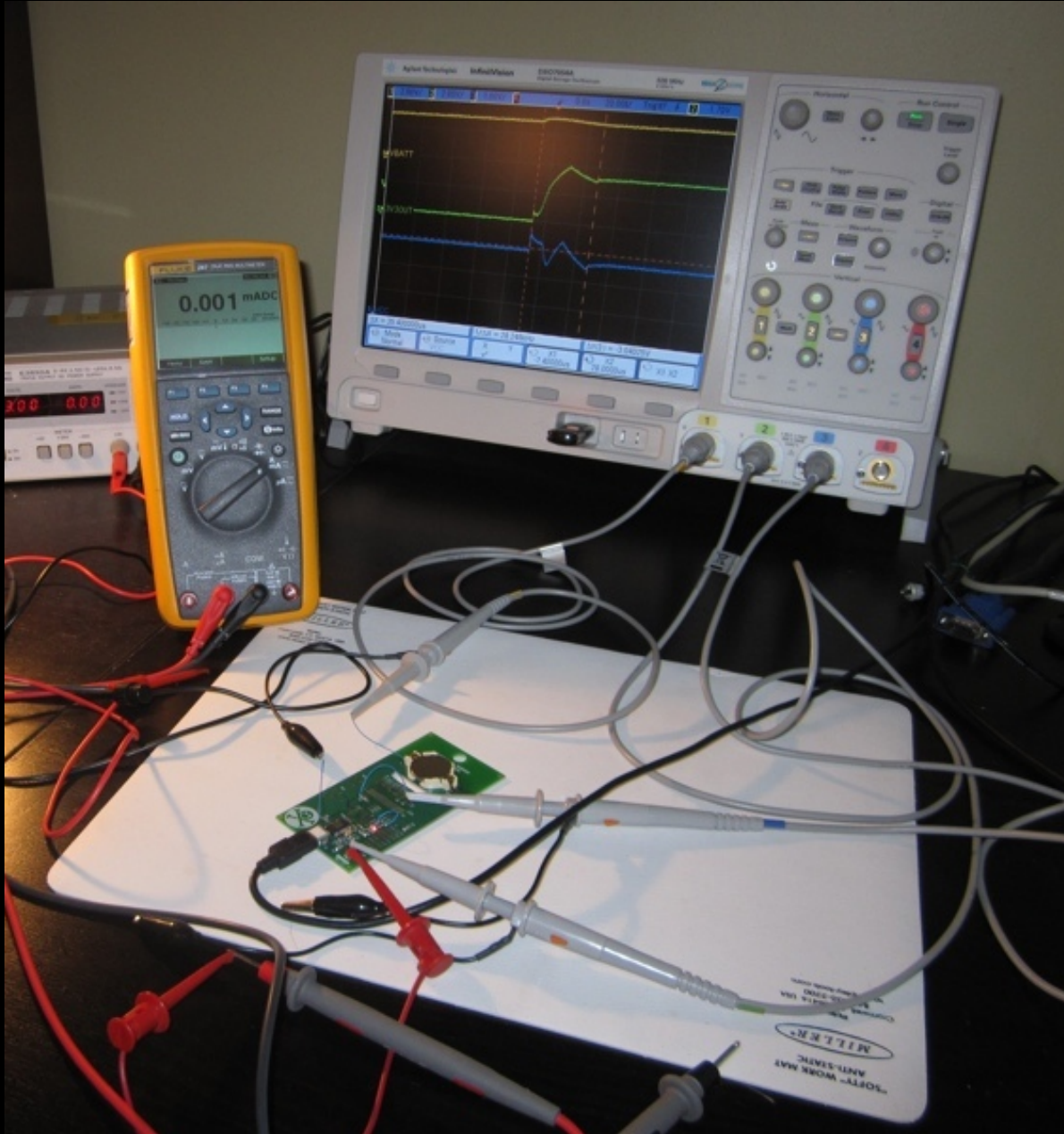

The Development Process

Picture Show 5

Writing low-level drivers

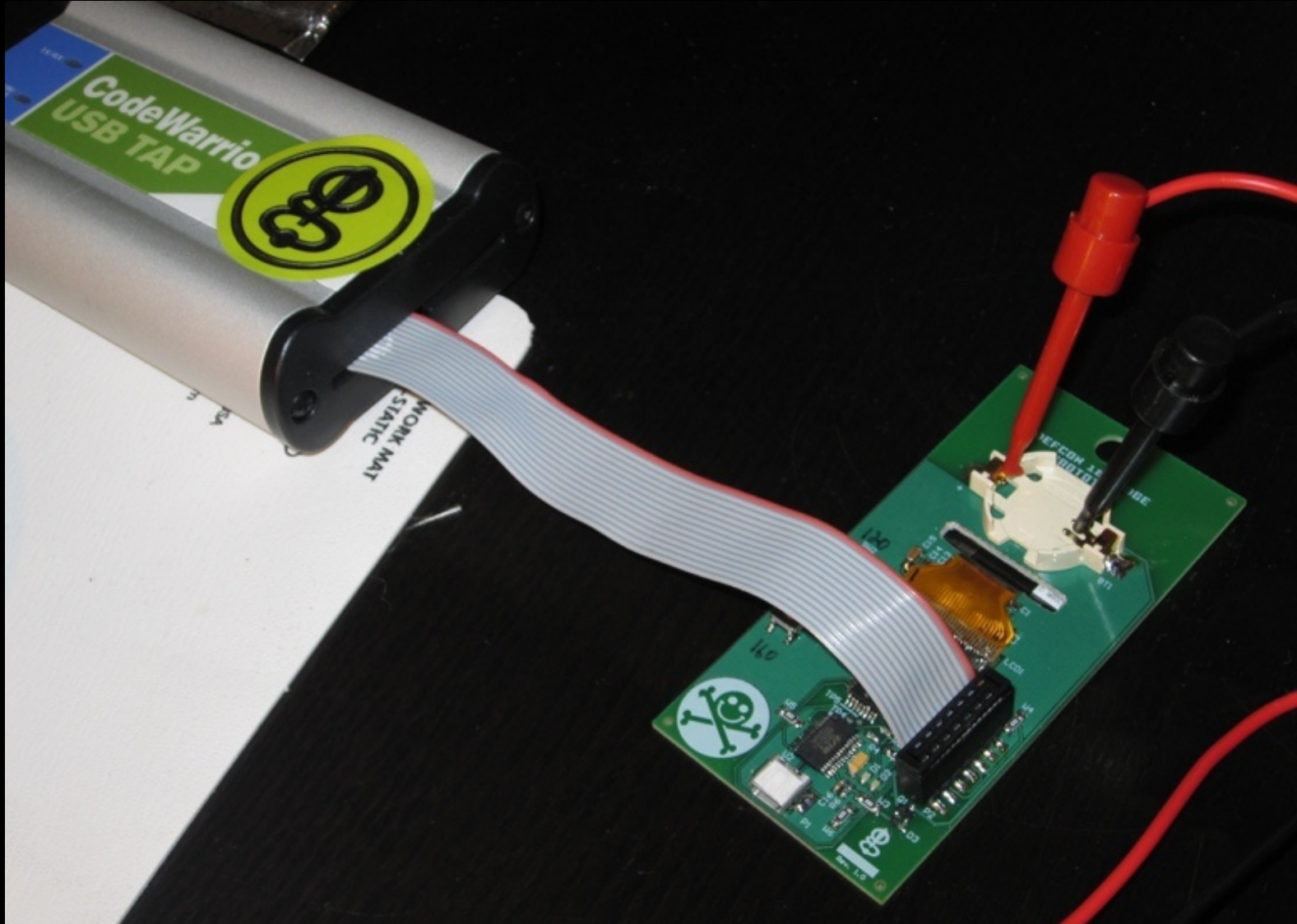

The Development Process

Picture Show 6

It works!



The Development Process Picture Show 7

Final firmware development

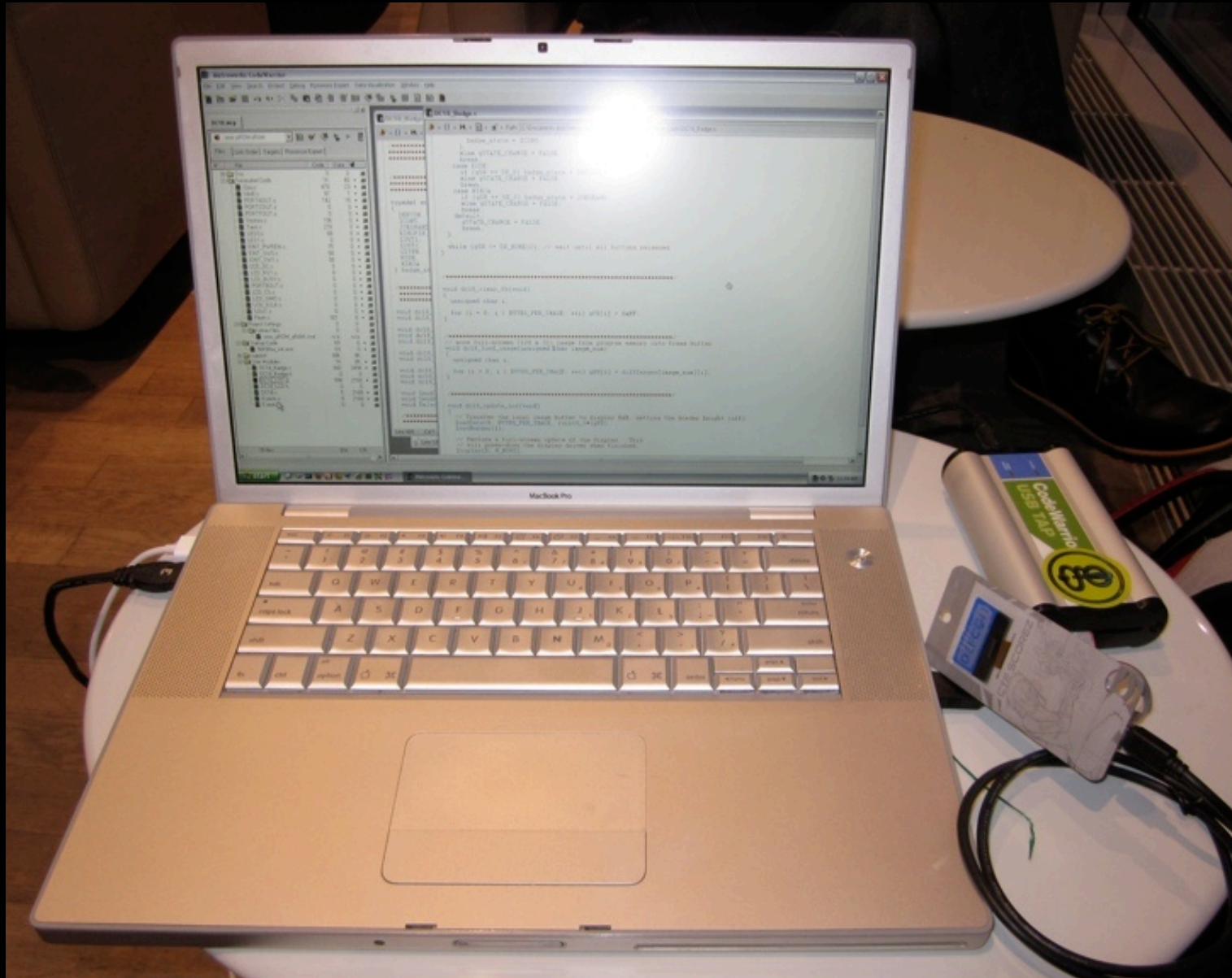

Laser Engraving!

- ★ 0.040" single-sided aluminum substrate PCB
- ★ Killer graphics by Neil, the DEFCON resident artist
- ★ Difficult to find a vendor that would take on this work
 - ★ ...and do it for an affordable price
 - ★ On aluminum? Yes. On circuit Board? No.



Laser Engraving! 2

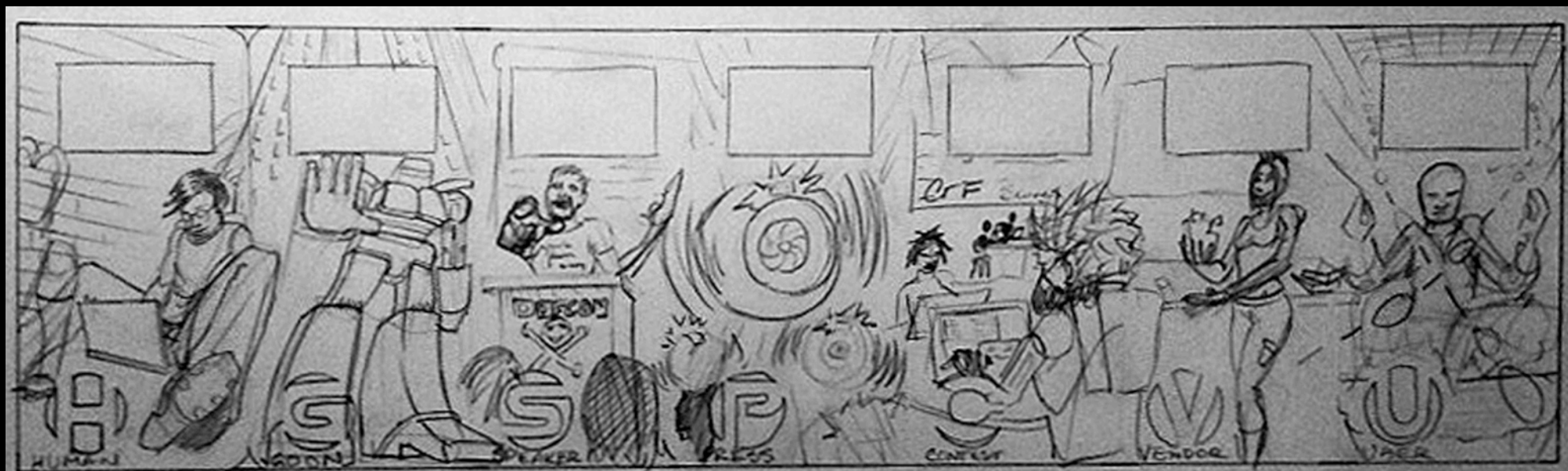

Laser Engraving! 3



Laser Engraving! 4

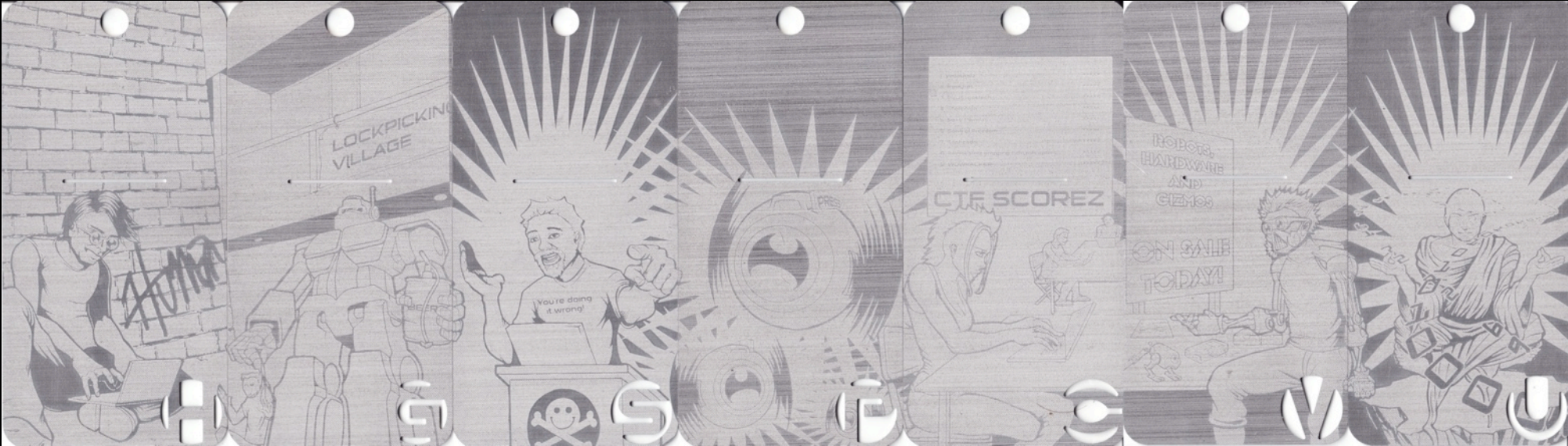

Freescal^e MC56F8006



★ Digital Signal Controller

- Part of the 56800/E family
- Main product page: <http://tinyurl.com/mc56f8006-info/>
- Direct link to data sheet: www.freescal^e.com/files/dsp/doc/data_sheet/MC56F8006.pdf



- 16KB of Flash
- 2KB of RAM
- 6-channel PWM
- 18-channel, 12-bit A/D
- Timer/RTC
- 2 PGA, 3 analog comparators
- Serial communication/UART/I²C/SPI
- Up to 22 GPIO
- 32-pin LQFP, 7mm x 7mm
- 1.8V-3.6V operation



Freescal e MC56F8006

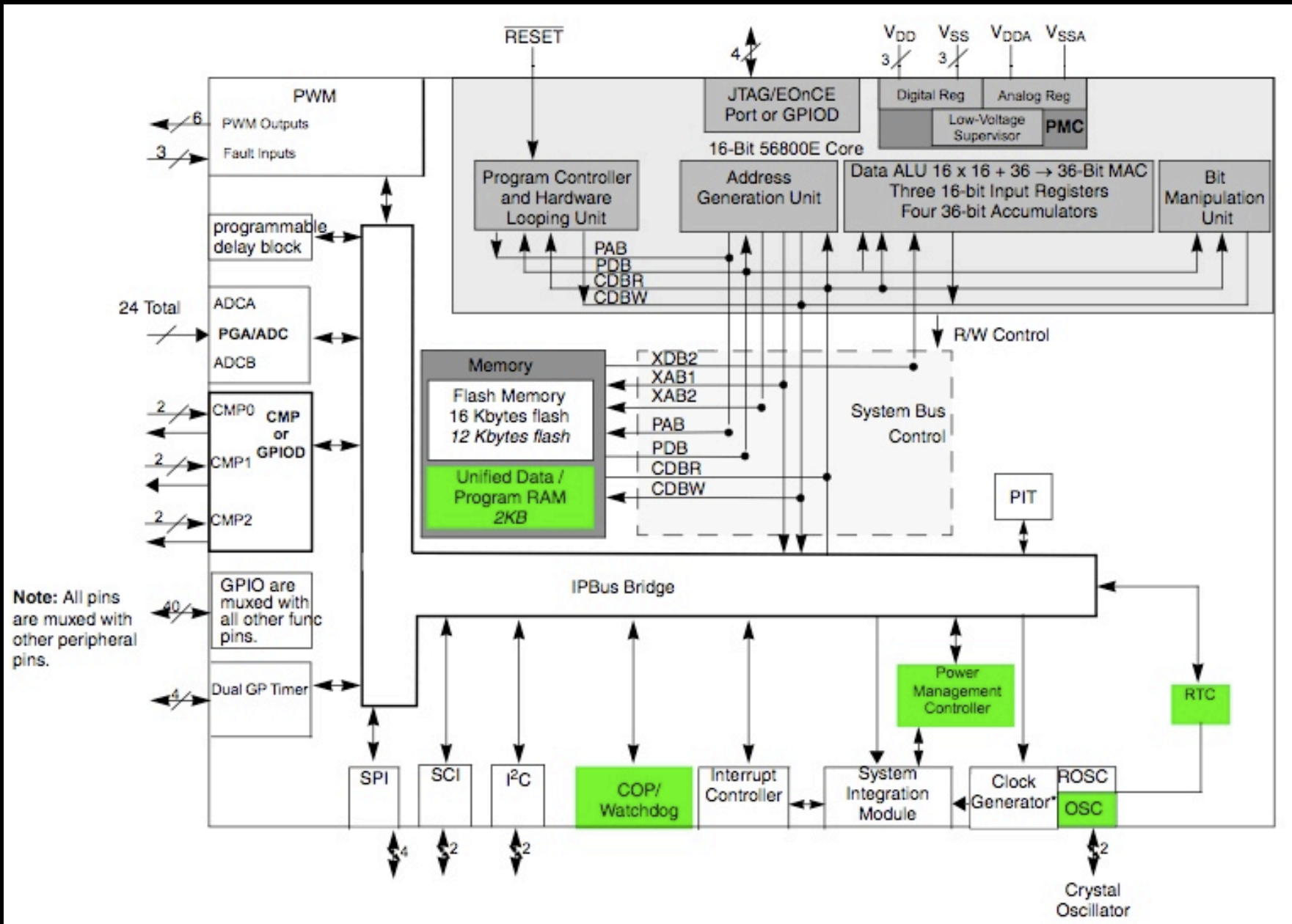

Kent Displays

Reflex Graphic Display Module

- 128 x 32 pixels, 118 DPI
- Reflective Cholesteric LCD
- Bistable = no power or refresh needed to retain image on screen
- Control via SPI-like slave serial interface
- Full screen update ~1.7 seconds
- Affixed to badge with 3M 468MP adhesive tape
- Originally designed for use in Verbatim InSight USB Portable Hard Drive
- Not used in the first moon landing



Kent Displays

Reflex Graphic Display Module

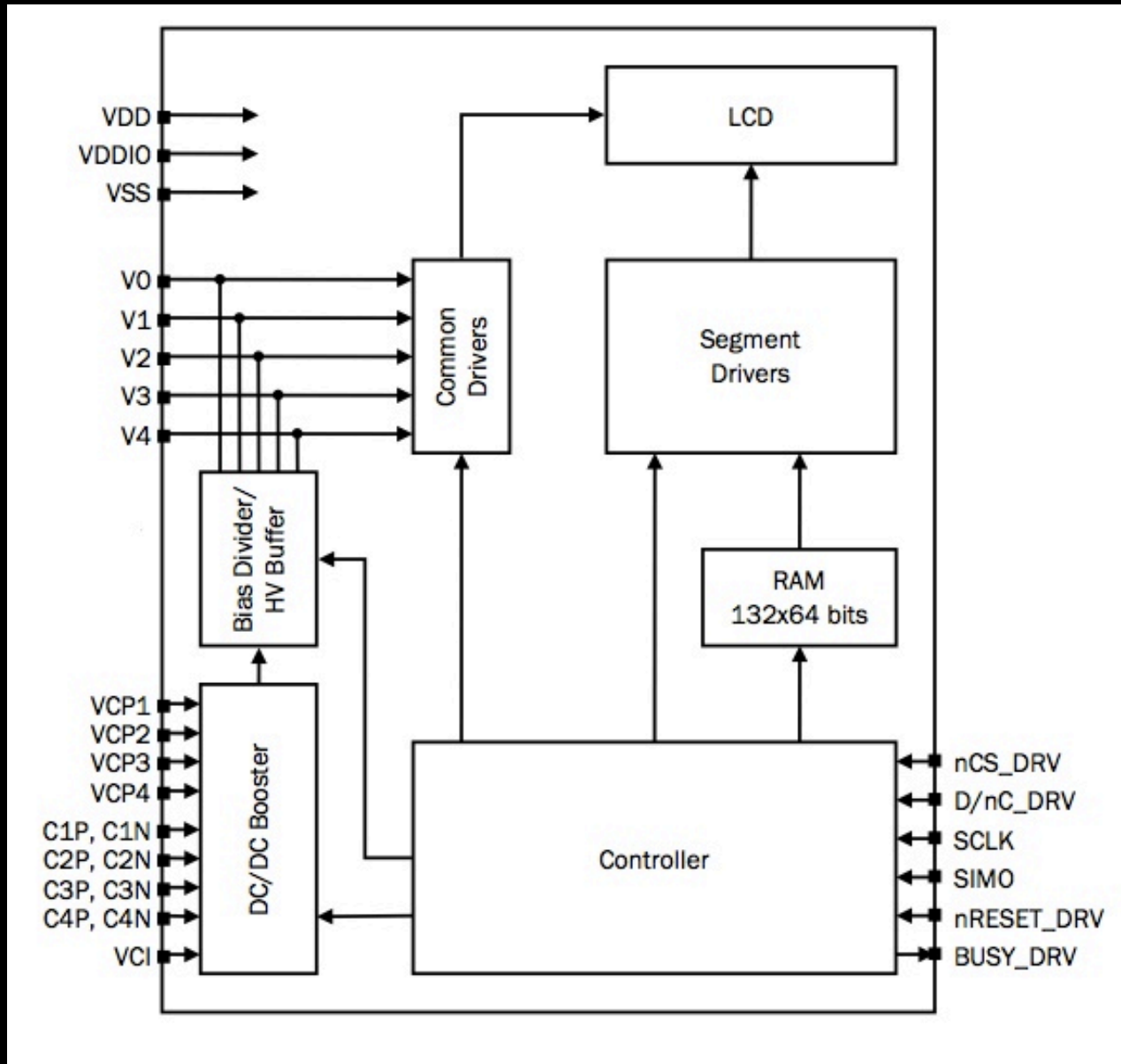

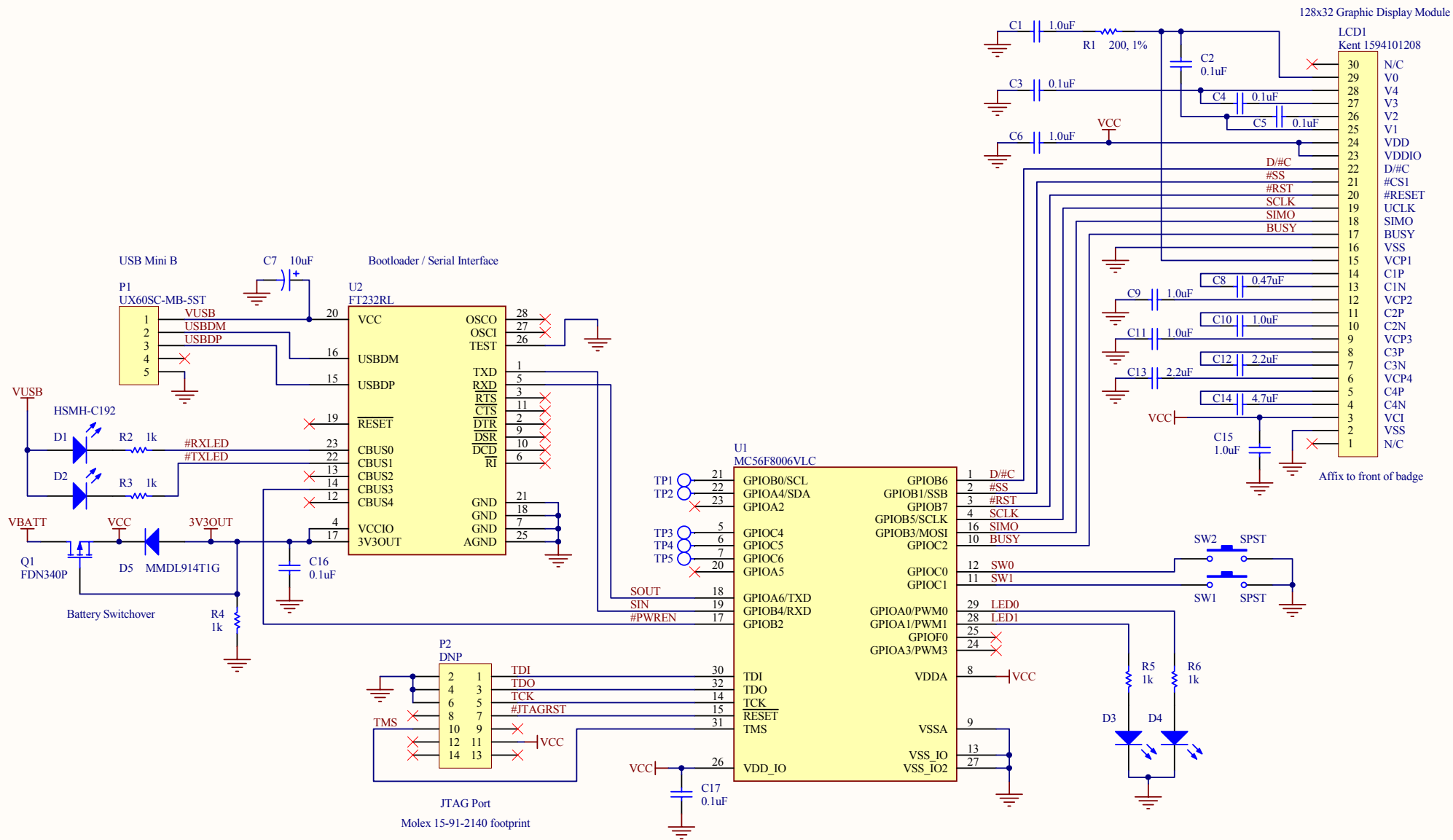

Schematic

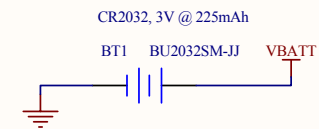
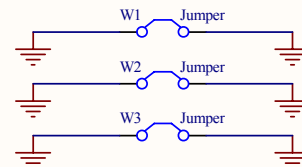
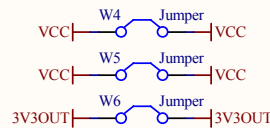

Bill-of-Materials

Quantity	Reference	Manufacturer	Manuf. Part #	Distributor	Distrib. Part #	Description	Unit Price	Per Badge
1	BT1	MPD	BU2032SM-JJ-GTR	Digi-Key	BU2032SM-JJ-GTR-ND	Single-cell battery holder for CR2032, SMD	\$0.40000	\$0.4060
1	N/A	Panasonic	CR2032	Digi-Key	P189-ND	CR2032 Lithium 3V Coin Cell Battery (225mAh)	\$0.13750	\$0.1375
6	C1,C6,C9,C10,C11,C15	TDK	C3216X7R1H105K	Digi-Key	445-1423-2-ND	1.0uF ceramic capacitor, 50V, X7R, 1206	\$0.03100	\$0.1943
6	C2,C3,C4,C5,C16,C17	Kemet	C0603C104K4RACTU	Digi-Key	399-1096-2-ND	0.1uF ceramic capacitor, 16V, X7R, 0603	\$0.00240	\$0.0143
1	C7	Kemet	T491A106M016AT	Newark	57K1640	10uF capacitor, 20%, 16V, tantalum, size A	\$0.06900	\$0.0693
1	C8	Taiyo Yuden	UMK212B7474KG-T	Digi-Key	587-1288-2-ND	0.47uF ceramic capacitor, 50V, X7R, 0805	\$0.03900	\$0.0524
2	C12,C13	Taiyo Yuden	TMK212BJ225KG-T	Digi-Key	587-1292-2-ND	2.2uF ceramic capacitor, 25V, X5R, 0805	\$0.02600	\$0.0582
1	C14	Kemet	C0603C475K8PACTU	Digi-Key	399-5503-2-ND	4.7uF ceramic capacitor, 10V, X5R, 0603	\$0.03900	\$0.0466
4	D1,D2,D3,D4	Avago	HSMH-C192	N/A	N/A	LED, Red, 0603, 1.8Vf, 17mcd @ 20mA	\$0.02900	N/A
1	D5	ON Semiconductor	MMDL914T1G	Mouser	863-MMDL914T1G	Diode, Switching, 100Vr, 1Vf @ 10mA, 5uA Ir @ 75V, SOD-323	\$0.02400	\$0.0251
1	LCD1	Kent Displays	1594101208	N/A	N/A	LCD, 128x32 Reflex Graphic Display Module	\$3.49000	\$3.4900
1	N/A	GM Nameplate	N/A	N/A	N/A	3M 468MP adhesive tape for LCD attachment, 1" x 1/2" strips	\$0.07870	\$0.0822
1	P1	Hirose	UX60SC-MB-5ST(80)	Digi-Key	H11671TR-ND	Connector, Mini-USB Type B, R/A, 5 position, SMD	\$0.37500	\$0.4198
1	Q1	Fairchild	FDN340P	Digi-Key	FDN340PTR-ND	Transistor, MOSFET, P-Channel, 20V, 2A, SSOT3/SOT23	\$0.11100	\$0.1160
1	R1	Yageo	RC0603FR-07200RL	Mouser	603-RC0603FR-07200RL	200 ohm, 1%, 1/10W, 0603	\$0.00200	\$0.0030
5	R2,R3,R4,R5,R6	Panasonic	ERJ-3GEYJ102V	Digi-Key	P1.0KGTR-ND	1k, 5%, 1/10W, 0603	\$0.00120	\$0.0063
2	SW1,SW2	C&K	KSC201JLFS	Digi-Key	401-1756-2-ND	SPST tactile momentary switch, 120gf, 6.2 x 6.2mm, J-Lead	\$0.16600	\$0.3469
1	U1	Freescall	MC56F8006VLC	Avnet	N/A	Microcontroller/Digital Signal Controller, LQFP32	\$1.50000	N/A
1	U2	FTDI	FT232RL	Mouser	895-FT232RL	USB-to-Serial UART Converter, SSOP28W	\$1.89000	\$1.8900
1	N/A	N/A	N/A	Avnet	N/A	Microcontroller programming service	\$0.10000	\$0.1000
6	W1,W2,W3,W4,W5,W6	Panasonic	ERJ-8GEY0R00V	Digi-Key	P0.0ETR-ND	Jumper, 0 ohm resistor, 1/4W, 1206	\$0.00380	\$0.0284
1	PCB	e-Teknet	DC18	N/A	N/A	PCB (fabrication, laser, assembly, test)	\$6.63000	\$6.6300

Approx. per badge cost = \$14.12 (!)

Big ticket items = LCD and laser engraving (\$3.84)



Assembly Drawing

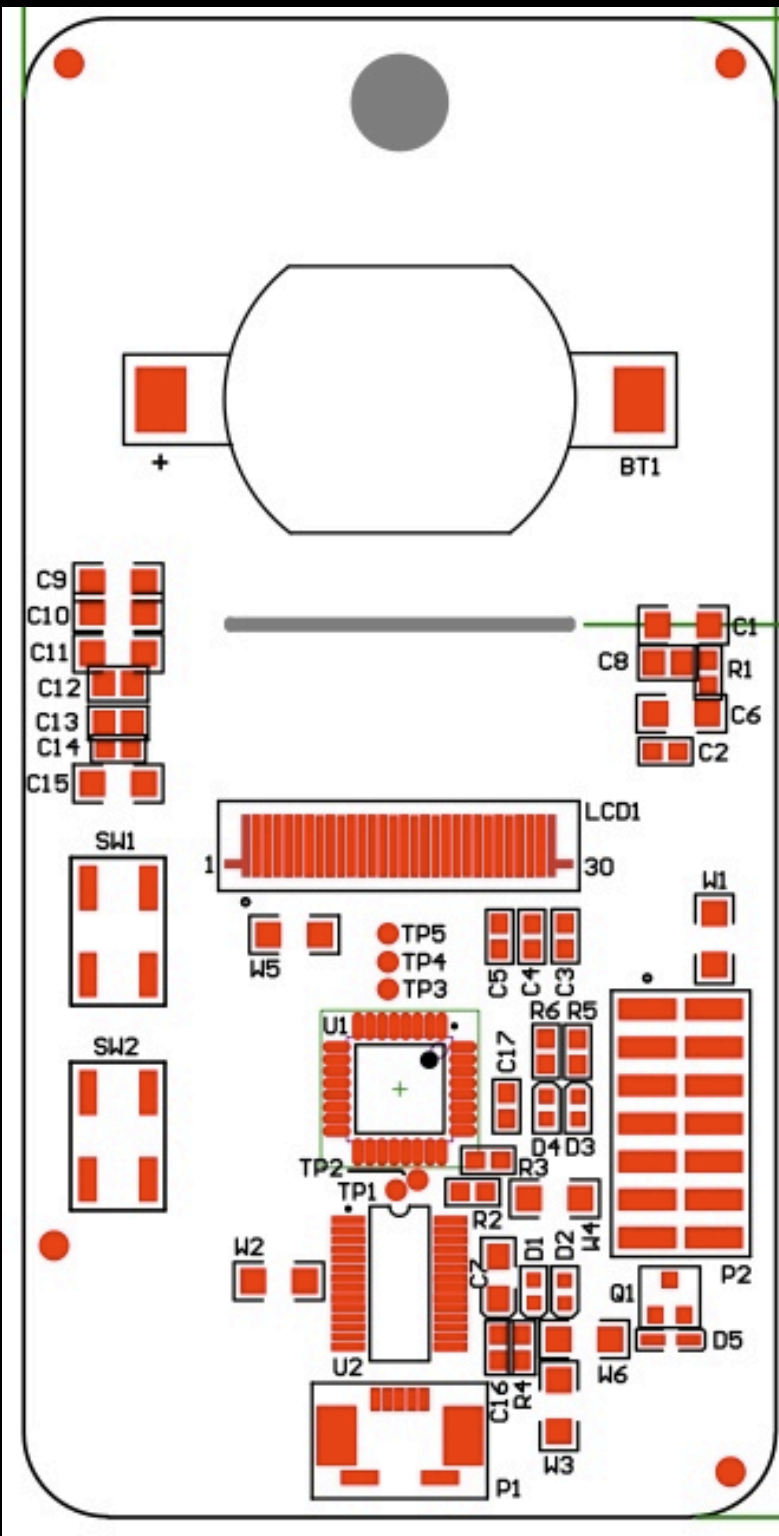

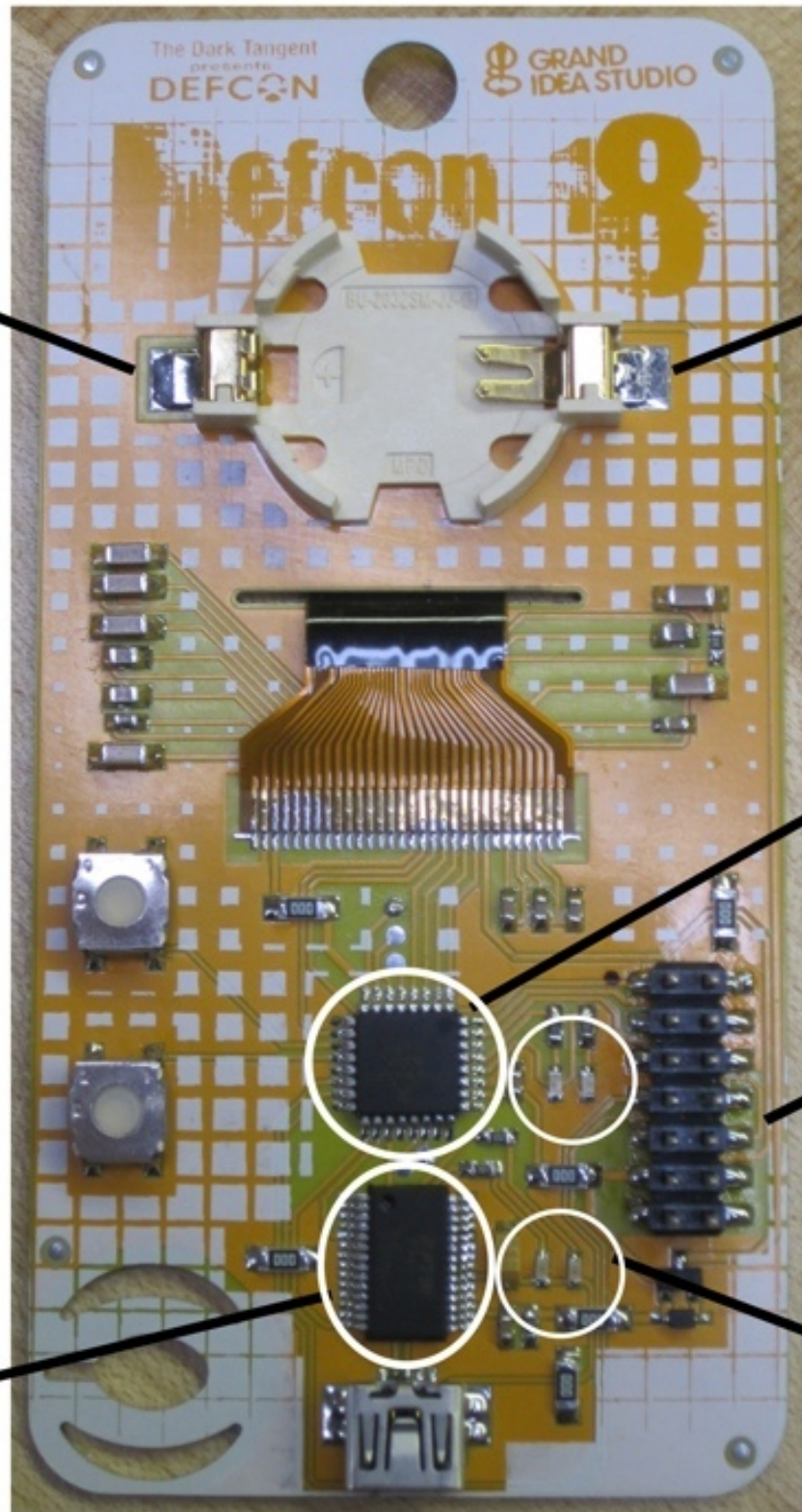

+

-

SW1

SW2

FT232RL

MC56F8006

JTAG

LEDs



Core Badge Functionality

- ★ Glyph selection
- ★ LCD control API
- ★ Secret modes



Glyph Selection

- ★ Choose your favorite 4 glyphs/icons to show off on your LCD
- ★ Now you don't have to talk to someone to find out if they have the same interests as you :)
- ★ Enter Glyph Selection mode by pressing SW2 from the DEFCON logo
- ★ Use SW1 and SW2 to cycle through the glyphs
- ★ Press SW1 and SW2 together to select the glyph
- ★ Lather, rinse, repeat



Glyph Selection 2

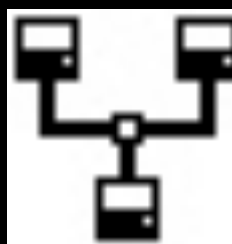

LCD Control API

- ★ Control the LCD via serial commands sent over USB virtual COM port
 - 9600, 8N1
- ★ Use terminal program or scripts
- ★ Display nifty graphics and text on the LCD
- ★ No hardware hacking experience necessary!



LCD Control API 2

With USB plugged in, send '#' to enable mode
Badge will return welcome string (in ASCII)

'C' = clear frame buffer

'L aa aa vv' = load byte vv into frame buffer
location aa

ex.: L 00 01 0A

valid locations 0x000 to 0x1FF

see LCD data sheet pg. 9 for mem. map

0 = pixel on (dark), 1 = pixel off (light)

'U' = update LCD w/ frame buffer contents

'X' (or power cycle) = exit LCD mode

Badge will return ACK ('.') after a valid command



LCD Control API 3

PAGE	BIT	COLUMN ADDRESS														
		0	1	2	3	4	...	127	128	129	130	131				
0	0-7	DON'T CARE					...	DON'T CARE								
1	0-6	DON'T CARE					...	DON'T CARE								
	7	B	B	B	B	B	...	B	B	B	B	B				
2	0	DON'T CARE	B	BYTE 0	BYTE 1	BYTE 2	...	BYTE 125	BYTE 126	BYTE 127	B	DON'T CARE				
	1		B								B		B			
	2		B								B		B			
	3		B								B		B			
	4		B								B		B			
	5		B								B		B			
	6		B								B		B			
	7		B								B		B			
3	0	DON'T CARE	B	BYTE 128	BYTE 129	BYTE 130	...	BYTE 253	BYTE 254	BYTE 255	B	DON'T CARE				
	1		B								B		B			
	2		B								B		B			
	3		B								B		B			
	4		B								B		B			
	5		B								B		B			
	6		B								B		B			
	7		B								B		B			
4	0	DON'T CARE	B	BYTE 256	BYTE 257	BYTE 258	...	BYTE 381	BYTE 382	BYTE 383	B	DON'T CARE				
	1		B								B		B			
	2		B								B		B			
	3		B								B		B			
	4		B								B		B			
	5		B								B		B			
	6		B								B		B			
	7		B								B		B			
5	0	DON'T CARE	B	BYTE 384	BYTE 385	BYTE 386	...	BYTE 509	BYTE 510	BYTE 511	B	DON'T CARE				
	1		B								B		B			
	2		B								B		B			
	3		B								B		B			
	4		B								B		B			
	5		B								B		B			
	6		B								B		B			
	7		B								B		B			
6	0	B	B	B	B	...	B	B	B	B	B					
	1-7	DON'T CARE					...	DON'T CARE								
7	0-7	DON'T CARE					...	DON'T CARE								



Secret Modes

Call-for-Integration to invite DEFCON participants to hide code and/or data in the badge (March 2010)

Lots of cool stuff? Find it all!



Other Badge Stuff You
Might Want To Know.



Development Environment

Freescal CodeWarrior for 56800/E Digital Signal Controllers

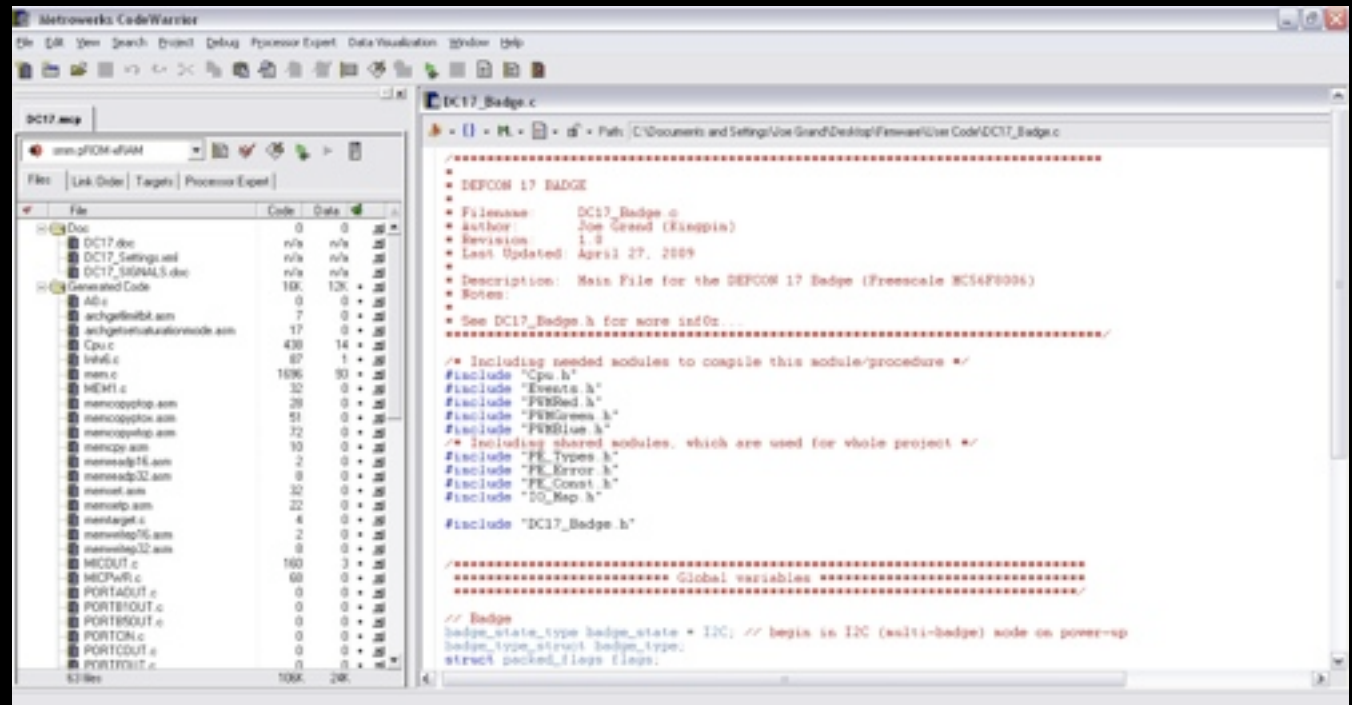

- ★ Special Edition free for up to 64KB Flash
- ★ Windows only, but works fine in a VM
- ★ All tools/materials on DEFCON CD
- ★ <http://tinyurl.com/mc56f8006-dev/>



Development Environment 2

Processor Expert

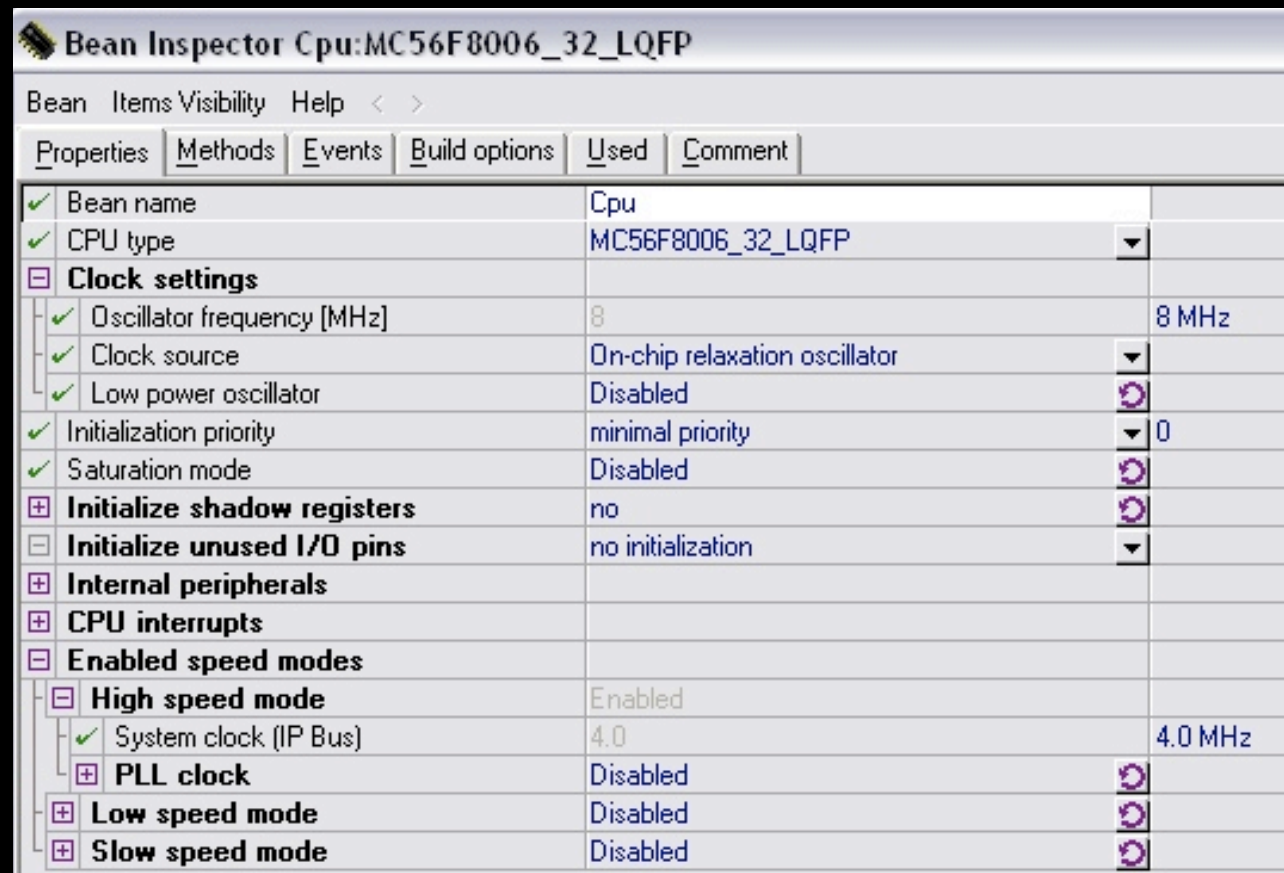
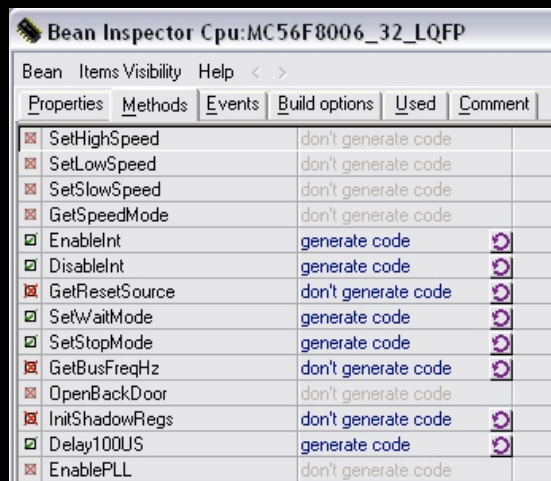

- ★ GUI for peripheral configuration
- ★ Generates required drivers/function code for desired modules



Static Serial Bootloader

- ★ USB port + terminal program = Load your own firmware onto the badge
- ★ Hold down SW1 & SW2 on power-up
 - ◎ Ideally by inserting USB cable (remove battery first)
 - ◎ Both top LEDs will remain on
 - ◎ Virtual USB COM port will appear on your machine
- ★ Use CodeWarrior dev. tools to hack/modify firmware and re-compile



Static Serial Bootloader 2

- ★ When modifying the User Code:
 - ⦿ Need to ensure reset and COP vectors point to `BOOTLOADER_ADDR` (0x1B00) and not user code!
 - ⦿ If you change the linker file, you'll need to re-patch it, as well
 - ⦿ Read the comments in `/CODE/cpu.c` for full details



Static Serial Bootloader 3

- ★ Send the hex file and the badge will do the rest...
 - 9600, 8N1, Xon/Xoff
 - /output/sdm_pROM_xRAM.elf.S
 - Typical load time ~90 seconds

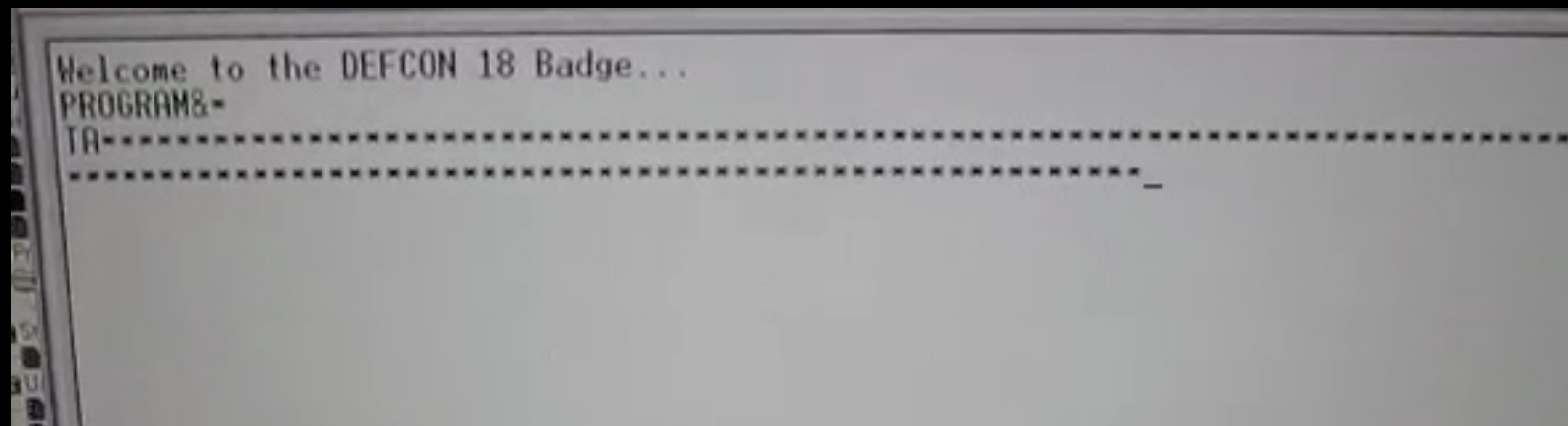

In Case Of Bricking...

- ★ MC56F8006 JTAG interface
 - ◎ Uses CodeWarrior USB TAP hardware,
www.freescale.com/webapp/sps/site/prod_summary.jsp?code=USBTAP
- ★ Just like last year, but 2x7 connector footprint is provided this time
- ★ Engineers are standing by in the Hardware Hacking Village
 - ◎ I brought ~100 connectors



In Case Of Bricking... 2

- ★ Use in conjunction with 56800E Flash Programmer tool to reload original firmware (including static bootloader)
 - `dc18-with-boot.s`
- ★ Only reprogram/debug with USB cable attached to ensure normal speed (non-reduced) operation
 - Device does not sleep when powered via USB



Converting BMP to C

- ★ Load your own graphics onto the badge
 - Requires Kent Display development tools (on CD)
 - Convert BMP to array and replace the one(s) in `graphics.h`

- ★ Maximum image size = 128 x 32 pixels
 1. Convert to 132 x 32 canvas size with image at far left
 2. BMP-to-C using "132x64 BMP to C" tool
 3. Erase unused bytes within resultant C file
 4. Copy relevant data into array



Converting BMP to C 2

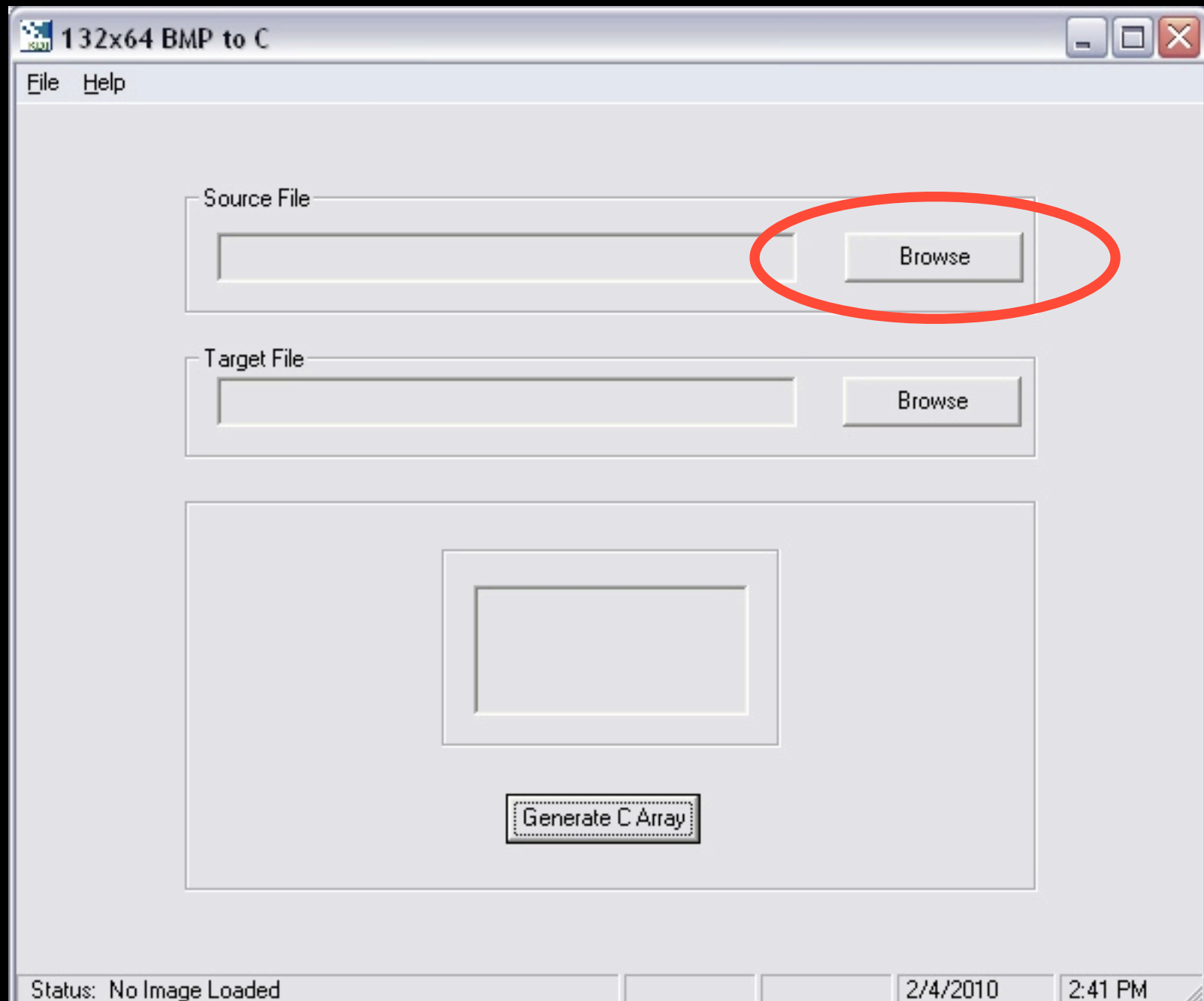

Converting BMP to C 3

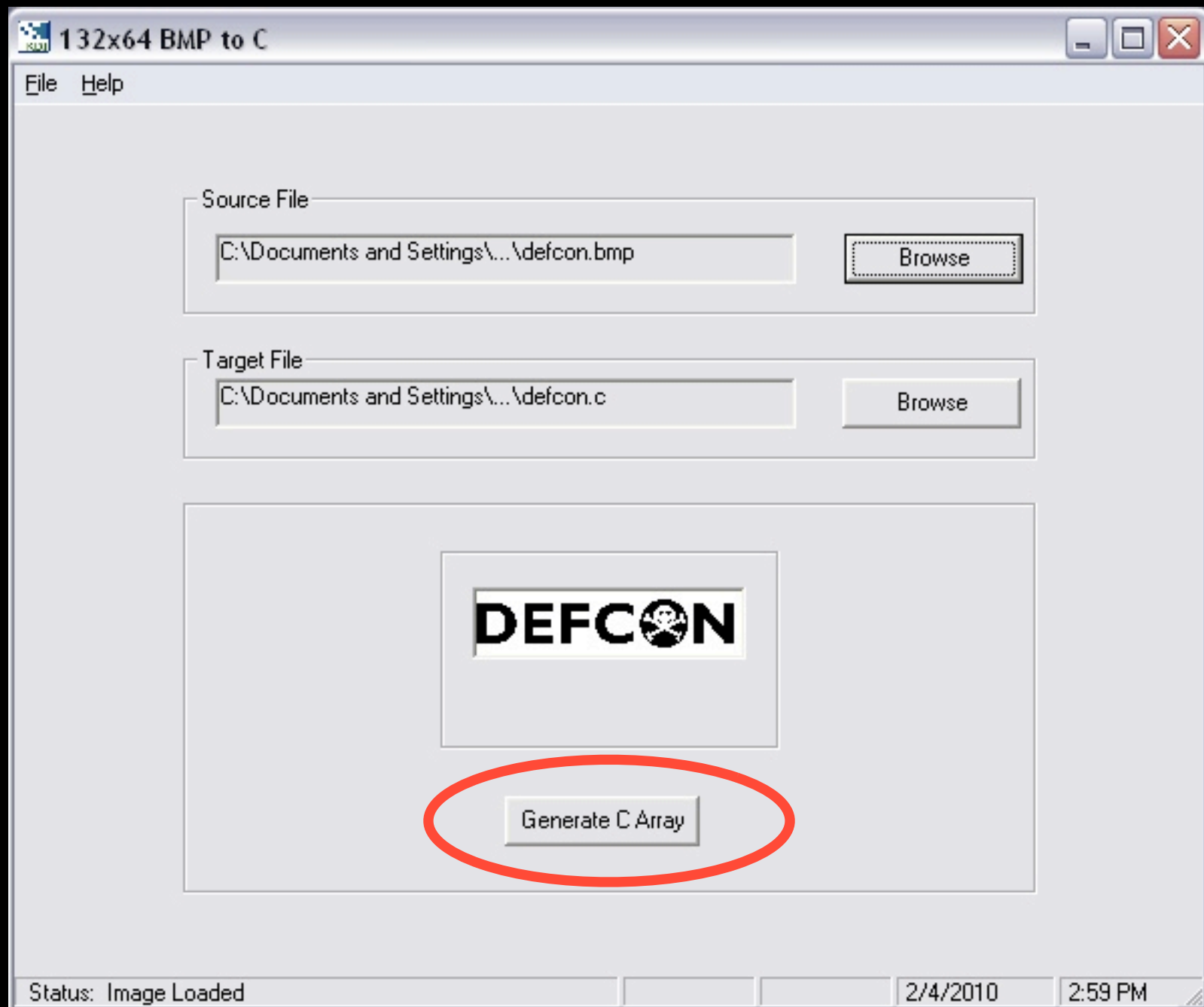

Converting BMP to C 4

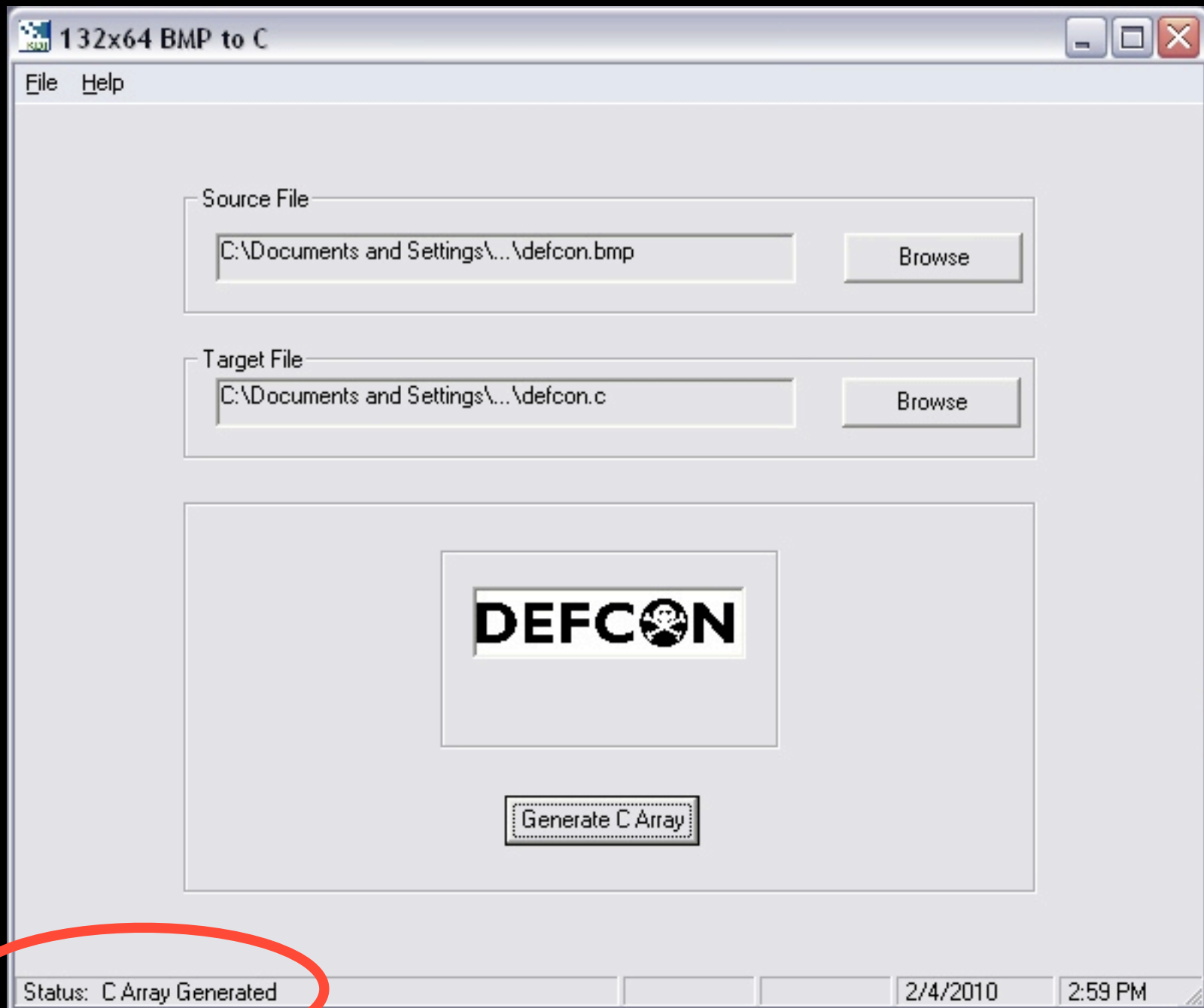

Converting BMP to C 5

```
1 // Note: uint8 must be typedef'd to an 8-bit unsigned integer in defines.h.
2 #include "defines.h"
3
4 // *****
5 // chlcd_tech
6 // *****
7 const uint8 chlcd_tech[512] = {
8     0xFF, 0xFF, 0xFF, 0xFF, 0x07, 0x03, 0xF9, 0xFD, 0xFD, 0xF9, 0xFB, 0xFF,
9     0x01, 0x01, 0xCF, 0xE7, 0xE7, 0x0F, 0x1F, 0xFF, 0x01, 0x01, 0xFF, 0xFF,
10    0xFF, 0xFF, 0xFF, 0x07, 0x03, 0xF9, 0xFD, 0xFD, 0xF9, 0xFB, 0xFF, 0x01,
11    0x01, 0xFD, 0xF9, 0x03, 0x07, 0xFF, 0xFF, 0xFF, 0xFF, 0xFF, 0xFF,
12    0xFF, 0xFF, 0xFF, 0xFF, 0xFF, 0xFF, 0xFD, 0xFD, 0x01, 0x01, 0xFD, 0xFD,
13    0xFF, 0x0F, 0x07, 0xB7, 0xB7, 0xB7, 0xB7, 0xFF, 0x0F, 0x07, 0xF7, 0xF7,
14    0xE7, 0xEF, 0xFF, 0x01, 0x01, 0xE7, 0xF7, 0x07, 0x0F, 0xFF, 0x07, 0x07,
15    0xF7, 0xF7, 0x07, 0x0F, 0xFF, 0x0F, 0x07, 0xF7, 0xF7, 0x0F, 0xFF,
16    0xFD, 0xFD, 0x01, 0x01, 0xFF, 0xFF, 0x0F, 0x0F, 0x07, 0xF7, 0x07,
17    0x0F, 0xFF, 0x0F, 0x07, 0x77, 0x77, 0x07, 0x0F, 0xFF, 0x07, 0x07, 0x7F,
18    0x7F, 0x07, 0x07, 0xFF, 0xFF, 0xFF, 0xFF, 0xFF,
19    0x07, 0x07, 0x07, 0x07, 0x07, 0x06, 0x04, 0x05, 0x05, 0x04, 0x06, 0xC7,
20    0xC4, 0xC4, 0xC7, 0x07, 0x07, 0x04, 0x04, 0x07, 0x04, 0x04, 0x05, 0xC5,
21    0xC5, 0xC5, 0xC7, 0xC7, 0xC6, 0xC4, 0xC5, 0x05, 0x04, 0x06, 0x07, 0xE4,
22    0xE4, 0x05, 0x04, 0xE6, 0xE7, 0x07, 0x07, 0x07, 0x07, 0x07, 0x07, 0x07,
23    0x07, 0x07, 0x07, 0x07, 0x07, 0x07, 0x07, 0x04, 0xE4, 0xE7, 0x07,
24    0x07, 0x06, 0x04, 0x05, 0x05, 0x05, 0x05, 0x07, 0x07, 0x06, 0xE4, 0xE5, 0xE5,
25    0x64, 0xE6, 0x07, 0x04, 0x04, 0x07, 0x07, 0x64, 0x64, 0x07, 0x04, 0x04,
26    0x07, 0x07, 0x04, 0x04, 0x07, 0x06, 0x04, 0x05, 0x05, 0x04, 0x06, 0x07,
27    0x05, 0x65, 0x64, 0xE4, 0xE5, 0x05, 0x07, 0x06, 0x04, 0x05, 0x05, 0x04,
28    0x06, 0x07, 0x07, 0x05, 0x05, 0x05, 0x04, 0x06, 0x07, 0x07, 0x05, 0x05,
29    0x05, 0x04, 0x06, 0x07, 0x07, 0x07, 0x07, 0x07,
30    0x00, 0x00, 0x00, 0x3C, 0x3C, 0x3C, 0x3C, 0xC0, 0xC0, 0xC0, 0xC0, 0x03,
31    0x03, 0x03, 0x03, 0x3C, 0x3C, 0x3C, 0x3C, 0xFC, 0xFC, 0xFC, 0xFC, 0xFF,
32    0xFF, 0xFF, 0xFF, 0xFF, 0xFF, 0xFF, 0xFF, 0x00, 0x00, 0x00, 0x00, 0xFF,
33    0xFF, 0x60, 0xFE, 0x9F, 0x01, 0x00, 0xF0, 0xFE, 0x06, 0x06, 0xFE, 0xF0,
34    0x00, 0xFE, 0xFE, 0x06, 0x06, 0xFE, 0xF8, 0x00, 0x06, 0xFF, 0xFF, 0x06,
35    0x06, 0x06, 0x00, 0x00, 0x00, 0x00, 0x00, 0x00, 0x00, 0x00, 0xFF, 0xFF,
36    0x00, 0x01, 0xFF, 0xFE, 0x00, 0x06, 0x06, 0xFE, 0xFE, 0x00, 0x00, 0x00,
37    0x70, 0xFE, 0x06, 0x06, 0x06, 0x06, 0x06, 0x00, 0xFE, 0xFE, 0x06, 0x06, 0xFE,
38    0xF0, 0x00, 0x00, 0xFF, 0xFF, 0x00, 0x00, 0x00, 0x00, 0x06, 0x06, 0x06,
39    0xFE, 0xF0, 0x00, 0xFE, 0xFE, 0x00, 0x00, 0xFE, 0xFE, 0x00, 0x70, 0xFE,
40    0x06, 0x06, 0x06, 0x06, 0x00, 0x00, 0x00, 0x00,
41    0x00, 0x00, 0x00, 0x00, 0x00, 0x00, 0x00, 0x00, 0x03, 0x03, 0x03, 0x03, 0x00,
42    0x00, 0x00, 0x00, 0x3C, 0x3C, 0x3C, 0x3C, 0x03, 0x03, 0x03, 0x03, 0x3F,
43    0x3F, 0x3F, 0x3F, 0x3F, 0x3F, 0x3F, 0x00, 0x00, 0x00, 0x00, 0x7F,
44    0x7F, 0x00, 0x07, 0x7F, 0x78, 0x00, 0x1F, 0x7F, 0x61, 0x61, 0x61, 0x01,
45    0x00, 0x7F, 0x7F, 0x00, 0x00, 0x00, 0x00, 0x00, 0x00, 0x00, 0x00, 0x60,
46    0x60, 0x60, 0x00, 0x00, 0x00, 0x00, 0x00, 0x00, 0x00, 0x00, 0x7F, 0x7F,
47    0x60, 0x78, 0x1F, 0x07, 0x00, 0x60, 0x60, 0x7F, 0x7F, 0x60, 0x60, 0x00,
48    0x60, 0x61, 0x61, 0x61, 0x7F, 0x1E, 0x00, 0x7F, 0x7F, 0x06, 0x06, 0x07,
49    0x01, 0x60, 0x60, 0x7F, 0x7F, 0x60, 0x60, 0x00, 0x1E, 0x7F, 0x61, 0x61,
50    0x7F, 0x7F, 0x00, 0x01, 0x67, 0x66, 0x66, 0x7F, 0x1F, 0x00, 0x60, 0x61,
51    0x61, 0x61, 0x7F, 0x1E, 0x00, 0x00, 0x00, 0x00
52 };
53
```

```
1 // Note: uint8 must be typedef'd to an 8-bit unsigned integer in defines.h.
2 #include "defines.h"
3
4 // *****
5 // defcon
6 // *****
7 const uint8 defcon[528] = {
8     0x3F, 0x3F, 0x3F, 0x3F, 0x3F, 0x3F, 0x3F, 0x3F, 0x3F, 0x3F, 0x3F, 0x3F,
9     0x3F, 0x7F, 0x7F, 0xFF, 0xFF, 0xFF, 0xFF, 0xFF, 0xFF, 0xFF, 0xFF, 0xFF,
10    0x3F, 0x3F, 0x3F, 0x3F, 0x3F, 0x3F, 0x3F, 0x3F, 0x3F, 0x3F, 0x3F, 0x3F,
11    0x3F, 0x3F, 0xFF, 0xFF, 0xFF, 0xFF, 0xFF, 0xFF, 0xFF, 0xFF, 0xFF, 0xFF,
12    0x3F, 0x3F, 0x3F, 0x3F, 0x3F, 0x3F, 0x3F, 0x3F, 0x3F, 0x3F, 0x3F, 0xFF,
13    0xFF, 0xFF, 0xFF, 0xFF, 0x7F, 0x7F, 0x3F, 0x3F, 0x3F, 0x3F, 0x3F, 0x3F,
14    0x3F, 0x3F, 0x3F, 0x3F, 0x7F, 0x7F, 0xFF, 0xFF, 0xFF, 0xFF, 0xFF, 0xFF,
15    0xFF, 0x7F, 0x3F, 0x1F, 0x1F, 0x1F, 0x0F, 0x0F, 0x0F, 0x0F, 0x0F, 0x0F,
16    0x3F, 0x3F, 0x1F, 0x1F, 0x3F, 0x3F, 0x7F, 0xFF, 0xFF, 0xFF, 0xFF, 0xFF,
17    0x3F, 0x3F, 0x3F, 0x3F, 0x3F, 0x7F, 0xFF, 0xFF, 0xFF, 0xFF, 0xFF, 0xFF,
18    0xFF, 0xFF, 0xFF, 0x3F, 0x3F, 0x3F, 0x3F, 0x3F, 0x3F, 0xFF, 0xFF, 0xFF, 0xFF,
19    0x00, 0x00, 0x00, 0x00, 0x00, 0xFC, 0xFC, 0xFC, 0xFC, 0xFC, 0xFC, 0xFF,
20    0xF8, 0xF8, 0x00, 0x00, 0x00, 0x00, 0x03, 0x07, 0x3F, 0x00, 0x00, 0xFF,
21    0x00, 0x00, 0x00, 0x00, 0x3C, 0x3C, 0x3C, 0x3C, 0x3C, 0x3C, 0x3C, 0x3C,
22    0x3C, 0xFC, 0xFF, 0xFF, 0xFF, 0xFF, 0x00, 0x00, 0x00, 0x00, 0x00, 0x3C,
23    0x3C, 0x3C, 0x3C, 0x3C, 0x3C, 0x3C, 0x3C, 0x3C, 0xFF, 0xFF, 0xFF, 0x1F,
24    0x07, 0x01, 0x00, 0x00, 0xC0, 0xF0, 0xF0, 0xF0, 0xFC, 0xFC, 0xFC, 0xFC,
25    0xFC, 0xFC, 0xFC, 0xF8, 0xF0, 0xF0, 0xFF, 0xFF, 0xFF, 0x3F, 0x07, 0x61,
26    0x70, 0x70, 0x60, 0xC0, 0xFC, 0xFE, 0xBF, 0x73, 0xFB, 0xFF, 0xF0, 0x73,
27    0xB0, 0xFE, 0xBC, 0xC0, 0xC0, 0x70, 0xF0, 0xC3, 0x0F, 0xFF, 0xFF, 0xFF,
28    0x00, 0x00, 0x00, 0x00, 0x00, 0x00, 0x00, 0x00, 0x00, 0x00, 0x00, 0x00,
29    0x7F, 0xFF, 0xFF, 0x00, 0x00, 0x00, 0x00, 0x00, 0x00, 0x00, 0x00, 0x00,
30    0x00, 0x00, 0x00, 0x00, 0x00, 0x3F, 0x3F, 0x3F, 0x3F, 0x3F, 0x3F, 0x3F,
31    0x1F, 0x0F, 0x00, 0x00, 0x00, 0xC0, 0xE0, 0xFC, 0xFF, 0xFF, 0xFF, 0xFF,
32    0x00, 0x00, 0x00, 0x00, 0x3C, 0x3C, 0x3C, 0x3C, 0x3C, 0x3C, 0x3C, 0x3C,
33    0x3C, 0x3F, 0x00, 0xFF, 0xFF, 0xFF, 0xFF, 0x00, 0x00, 0x00, 0x00, 0xFC,
34    0xFC, 0xFC, 0xFC, 0xFC, 0xFC, 0xFC, 0xFC, 0xFF, 0xFF, 0xFF, 0xF0,
35    0xE0, 0x00, 0x00, 0x00, 0x03, 0x0F, 0x1F, 0x1F, 0x3F, 0x3F, 0x3F, 0x3F,
36    0x3F, 0x3F, 0x1F, 0x1F, 0x0F, 0x0F, 0xFF, 0xFF, 0xFF, 0xFC, 0xE0, 0x00,
37    0x20, 0x0F, 0xE0, 0xE0, 0x00, 0x30, 0x19, 0x1B, 0x0F, 0x0F, 0x07, 0x0F, 0x0F,
38    0x1B, 0x19, 0x31, 0x60, 0xE0, 0x30, 0x00, 0xC0, 0xF0, 0xFF, 0xFF, 0xFF,
39    0x00, 0x00, 0x00, 0x00, 0x00, 0xFF, 0xFF, 0xFF, 0xFF, 0xFF, 0xFF, 0xFF,
40    0xC0, 0x00, 0x01, 0x00, 0x00, 0x00, 0x00, 0x00, 0x00, 0x00, 0x00, 0x00,
41    0xFC, 0xFC, 0xFC, 0xFC, 0xFC, 0xFC, 0xFC, 0xFC, 0xFC, 0xFC, 0xFC, 0xFC,
42    0xFE, 0xFE, 0xFE, 0xFF, 0xFF, 0xFF, 0xFF, 0xFF, 0xFF, 0xFF, 0xFF, 0xFF, 0xFF,
43    0xFC, 0xFC, 0xFC, 0xFC, 0xFC, 0xFC, 0xFC, 0xFC, 0xFC, 0xFC, 0xFC, 0xFC,
44    0xFC, 0xFC, 0xFF, 0xFF, 0xFF, 0xFF, 0xFF, 0xFF, 0xFC, 0xFC, 0xFC, 0xFC,
45    0xFF, 0xFF, 0xFF, 0xFF, 0xFF, 0xFF, 0xFF, 0xFF, 0xFF, 0xFF, 0xFF, 0xFF,
46    0xFC, 0xFC, 0xFC, 0xFE, 0xFE, 0xFE, 0xFF, 0xFF, 0xFF, 0xFF, 0xFF, 0xFF,
47    0xFF, 0xFE, 0xFD, 0xF0, 0xF0, 0xF0, 0xF0, 0xF0, 0xF0, 0xF0, 0xF0, 0xF0,
48    0xF0, 0xF0, 0xF0, 0xFC, 0xFD, 0xFE, 0xFF, 0xFF, 0xFF, 0xFF, 0xFF, 0xFF,
49    0xFC, 0xFC, 0xFC, 0xFC, 0xFC, 0xFF, 0xFF, 0xFF, 0xFF, 0xFF, 0xFF, 0xFF,
50    0xFF, 0xFF, 0xFF, 0xFC, 0xFC, 0xFC, 0xFC, 0xFF, 0xFF, 0xFF, 0xFF, 0xFF,
51    0xFF, 0xFF, 0xFF, 0xFF, 0xFF, 0xFF, 0xFF, 0xFF, 0xFF, 0xFF, 0xFF, 0xFF,
52 };
53
```



Converting BMP to C 6

```
1 // Note: uint8 must be typedef'd to an 8-bit unsigned integer in defines.h.
2 #include "defines.h"
3
4 // *****
5 // chlcd_tech
6 // *****
7 const uint8 chlcd_tech[512] = {
8 0xFF, 0xFF, 0xFF, 0xFF, 0x07, 0x03, 0xF9, 0xFD, 0xFD, 0xF9, 0xFB, 0xFF,
9 0x01, 0x01, 0xCF, 0xE7, 0xE7, 0x0F, 0x1F, 0xFF, 0x01, 0x01, 0xFF, 0xFF,
10 0xFF, 0xFF, 0xFF, 0x07, 0x03, 0xF9, 0xFD, 0xFD, 0xF9, 0xFB, 0xFF, 0x01,
11 0x01, 0xFD, 0xF9, 0x03, 0x07, 0xFF, 0xFF, 0xFF, 0xFF, 0xFF, 0xFF,
12 0xFF, 0xFF, 0xFF, 0xFF, 0xFF, 0xFF, 0xFD, 0xFD, 0x01, 0x01, 0xFD, 0xFD,
13 0xFF, 0x0F, 0x07, 0x07, 0xB7, 0x07, 0x0F, 0xFF, 0x0F, 0x07, 0xF7, 0xF7,
14 0xE7, 0xEF, 0xFF, 0x01, 0x01, 0xE7, 0xF7, 0x07, 0x0F, 0xFF, 0x07, 0x07,
15 0xF7, 0xF7, 0x07, 0x0F, 0xFF, 0xFF, 0x0F, 0xF7, 0xF7, 0x0F, 0xFF,
16 0xFD, 0xFD, 0x01, 0x01, 0xFF, 0xFF, 0xFF, 0x0F, 0x07, 0xF7, 0x07,
17 0x0F, 0xFF, 0x0F, 0x07, 0x77, 0x77, 0x07, 0x0F, 0xFF, 0x07, 0x07, 0x7F,
18 0x7F, 0x07, 0x07, 0xFF, 0xFF, 0xFF, 0xFF, 0xFF,
19 0x07, 0x07, 0x07, 0x07, 0x07, 0x06, 0x04, 0x05, 0x05, 0x04, 0x06, 0xC7,
20 0xC4, 0xC4, 0xC7, 0x07, 0x07, 0x04, 0x04, 0x07, 0x04, 0x04, 0x05, 0xC5,
21 0xC5, 0xC5, 0xC7, 0xC7, 0xC6, 0xC4, 0xC5, 0x05, 0x04, 0x06, 0x07, 0xE4,
22 0xE4, 0x05, 0x04, 0xE6, 0xE7, 0x07, 0x07, 0x07, 0x07, 0x07, 0x07, 0x07,
23 0x07, 0x07, 0x07, 0x07, 0x07, 0x07, 0x07, 0x04, 0xE4, 0xE7, 0x07,
24 0x07, 0x06, 0x04, 0x05, 0x05, 0x05, 0x05, 0x07, 0x07, 0x06, 0x04, 0xE5,
25 0x64, 0xE6, 0x07, 0x04, 0x04, 0x07, 0x07, 0x64, 0x64, 0x07, 0x04, 0x04,
26 0x07, 0x07, 0x04, 0x04, 0x07, 0x06, 0x04, 0x05, 0x05, 0x04, 0x06, 0x07,
27 0x05, 0x05, 0x64, 0xE4, 0xE5, 0x05, 0x07, 0x06, 0x04, 0x05, 0x05, 0x04,
28 0x06, 0x07, 0x07, 0x05, 0x05, 0x05, 0x05, 0x04, 0x06, 0x07, 0x07, 0x05,
29 0x05, 0x04, 0x06, 0x07, 0x07, 0x07, 0x07, 0x07,
30 0x00, 0x00, 0x00, 0x3C, 0x3C, 0x3C, 0x3C, 0x00, 0x00, 0x00, 0x00, 0x03,
31 0x03, 0x03, 0x03, 0x3C, 0x3C, 0x3C, 0x3C, 0xFC, 0xFC, 0xFC, 0xFC, 0xFF,
32 0xFF, 0xFF, 0xFF, 0xFF, 0xFF, 0xFF, 0x00, 0x00, 0x00, 0x00, 0xFF,
33 0xFF, 0x60, 0xFE, 0x9F, 0x01, 0x00, 0xF8, 0xFE, 0x86, 0x86, 0xFE, 0xF8,
34 0x00, 0xFE, 0xFE, 0x06, 0x06, 0xFE, 0xF8, 0x00, 0x06, 0xFF, 0xFF, 0x06,
35 0x06, 0x06, 0x00, 0x00, 0x00, 0x00, 0x00, 0x00, 0x00, 0xFF, 0xFF,
36 0x00, 0x01, 0xFF, 0xFE, 0x00, 0x06, 0x06, 0xFE, 0xFE, 0x00, 0x00, 0x00,
37 0x78, 0xFE, 0x06, 0x06, 0x86, 0x06, 0x06, 0x06, 0xFE, 0xFE, 0x06, 0x06,
38 0xF8, 0x00, 0x00, 0xFF, 0xFF, 0x00, 0x00, 0x00, 0x00, 0x86, 0x86, 0x86,
39 0xFE, 0xF8, 0x00, 0xFE, 0xFE, 0x00, 0x00, 0xFE, 0xFE, 0x00, 0x70, 0xFE,
40 0x86, 0x86, 0x86, 0x86, 0x00, 0x00, 0x00, 0x00,
41 0x00, 0x00, 0x00, 0x00, 0x00, 0x00, 0x00, 0x03, 0x03, 0x03, 0x03, 0x00,
42 0x00, 0x00, 0x00, 0x3C, 0x3C, 0x3C, 0x3C, 0x03, 0x03, 0x03, 0x03, 0x3F,
43 0x3F, 0x3F, 0x3F, 0x3F, 0x3F, 0x3F, 0x00, 0x00, 0x00, 0x00, 0x7F,
44 0x7F, 0x00, 0x07, 0x7F, 0x78, 0x00, 0x1F, 0x7F, 0x61, 0x61, 0x61, 0x01,
45 0x00, 0x7F, 0x7F, 0x00, 0x00, 0x00, 0x7F, 0x00, 0x00, 0x1F, 0x7F, 0x60,
46 0x60, 0x60, 0x00, 0x00, 0x00, 0x00, 0x00, 0x00, 0x00, 0x7F, 0x7F,
47 0x60, 0x78, 0x1F, 0x07, 0x00, 0x60, 0x60, 0x7F, 0x7F, 0x60, 0x60, 0x00,
48 0x60, 0x61, 0x61, 0x61, 0x7F, 0x1E, 0x00, 0x7F, 0x7F, 0x06, 0x06, 0x07,
49 0x01, 0x60, 0x60, 0x7F, 0x7F, 0x60, 0x00, 0x1E, 0x7F, 0x61, 0x61,
50 0x7F, 0x7F, 0x00, 0x01, 0x67, 0x66, 0x66, 0x7F, 0x1F, 0x00, 0x60, 0x61,
51 0x61, 0x61, 0x7F, 0x1E, 0x00, 0x00, 0x00, 0x00
52 };
53
```

```
1 // Note: uint8 must be typedef'd to an 8-bit unsigned integer in defines.h.
2 #include "defines.h"
3
4 // *****
5 // defcon
6 // *****
7 const uint8 defcon[528] = {
8 0x3F, 0x3F, 0x3F, 0x3F, 0x3F, 0x3F, 0x3F, 0x3F, 0x3F, 0x3F, 0x3F, 0x3F,
9 0x3F, 0x7F, 0x7F, 0xFF, 0xFF, 0xFF, 0xFF, 0xFF, 0xFF, 0xFF, 0xFF, 0xFF,
10 0x3F, 0x3F, 0x3F, 0x3F, 0x3F, 0x3F, 0x3F, 0x3F, 0x3F, 0x3F, 0x3F, 0x3F,
11 0x3F, 0x3F, 0xFF, 0xFF, 0xFF, 0xFF, 0x3F, 0x3F, 0x3F, 0x3F, 0x3F, 0x3F,
12 0xFF, 0xFF, 0xFF, 0xFF, 0x7F, 0x7F, 0x3F, 0x3F, 0x3F, 0x3F, 0x3F, 0x3F,
13 0x3F, 0x3F, 0x3F, 0x3F, 0x7F, 0x7F, 0xFF, 0xFF, 0xFF, 0xFF, 0xFF, 0xFF,
14 0xFF, 0x7F, 0x3F, 0x1F, 0x1F, 0x1F, 0x0F, 0x0F, 0x0F, 0x0F, 0x0F,
15 0x0F, 0x1F, 0x1F, 0x1F, 0x3F, 0x3F, 0x7F, 0xFF, 0xFF, 0xFF, 0xFF, 0xFF,
16 0x3F, 0x3F, 0x3F, 0x3F, 0x3F, 0x7F, 0xFF, 0xFF, 0xFF, 0xFF, 0xFF, 0xFF,
17 0xFF, 0xFF, 0xFF, 0x3F, 0x3F, 0x3F, 0x3F, 0x3F,
18 0x00, 0x00, 0x00, 0x00, 0x00, 0x00, 0xFC, 0xFC, 0xFC, 0xFC, 0xFC, 0xFC,
19 0xF8, 0xF8, 0x00, 0x00, 0x00, 0x00, 0x03, 0x03, 0x07, 0x07, 0x07, 0xFF,
20 0x00, 0x00, 0x00, 0x00, 0x3C, 0x3C, 0x3C, 0x3C, 0x3C, 0x3C, 0x3C, 0x3C,
21 0x3C, 0xFC, 0xFF, 0xFF, 0xFF, 0xFF, 0x00, 0x00, 0x00, 0x00, 0x00, 0x3C,
22 0x3C, 0x3C, 0x3C, 0x3C, 0x3C, 0x3C, 0x3C, 0x3C, 0xFF, 0xFF, 0xFF, 0xFF,
23 0x07, 0x01, 0x00, 0x00, 0x00, 0xC0, 0xF0, 0xF8, 0xF8, 0xF8, 0xF8, 0xFC,
24 0xFC, 0xFC, 0xFC, 0xF8, 0xF8, 0xF0, 0xFF, 0xFF, 0xFF, 0x3F, 0x07, 0x61,
25 0x78, 0x78, 0x60, 0xC0, 0xFC, 0xFE, 0xBF, 0x73, 0xFB, 0xFF, 0xFB, 0x73,
26 0x0B, 0xFE, 0xBC, 0xC0, 0xC0, 0x78, 0xF8, 0xC3, 0x0F, 0xFF, 0xFF, 0xFF,
27 0x00, 0x00, 0x00, 0x00, 0x00, 0x00, 0x00, 0x00, 0x01, 0x07, 0x0F, 0x1F, 0x3F,
28 0x7F, 0xFF, 0xFF, 0x00, 0x00, 0x00, 0x00, 0x00, 0x00, 0x00, 0x00,
29 0x00, 0x00, 0x00, 0x00, 0x00, 0x3F, 0x3F, 0x3F, 0x3F, 0x3F, 0x3F, 0x1F,
30 0x1F, 0x0F, 0x00, 0x00, 0x00, 0x00, 0xC0, 0xE0, 0xFC, 0xFF, 0xFF, 0xFF,
31 0x00, 0x00, 0x00, 0x00, 0x3C, 0x3C, 0x3C, 0x3C, 0x3C, 0x3C, 0x3C, 0x3C,
32 0x3C, 0x3F, 0xFF, 0xFF, 0xFF, 0xFF, 0x00, 0x00, 0x00, 0x00, 0xFF, 0xFC,
33 0xFC, 0xFC, 0xFC, 0xFC, 0xFC, 0xFC, 0xFC, 0xFF, 0xFF, 0xFF, 0xF8,
34 0xE0, 0x80, 0x00, 0x00, 0x03, 0x0F, 0x1F, 0x1F, 0x3F, 0x3F, 0x3F, 0x3F,
35 0x3F, 0x3F, 0x1F, 0x1F, 0x1F, 0x0F, 0xFF, 0xFF, 0xFF, 0xFC, 0xE0, 0x80,
36 0x20, 0xF0, 0xE0, 0x00, 0x00, 0x30, 0x19, 0x1B, 0x0F, 0x0F, 0x07, 0x0F,
37 0x1B, 0x19, 0x31, 0xB0, 0xE0, 0x30, 0x00, 0xC0, 0xF0, 0xFF, 0xFF, 0xFF,
38 0x00, 0x00, 0x00, 0x00, 0x00, 0xFF, 0xFF, 0xFF, 0xFE, 0xF8, 0xF0, 0xE0,
39 0xC0, 0x00, 0x01, 0x00, 0x00, 0x00, 0x00, 0x00,
40 0xFC, 0xFC, 0xFC, 0xFC, 0xFC, 0xFC, 0xFC, 0xFC, 0xFC, 0xFC, 0xFC, 0xFC,
41 0xFE, 0xFE, 0xFE, 0xFF, 0xFF, 0xFF, 0xFF, 0xFF, 0xFF, 0xFF, 0xFF, 0xFF,
42 0xFC, 0xFC, 0xFC, 0xFC, 0xFC, 0xFC, 0xFC, 0xFC, 0xFC, 0xFC, 0xFC, 0xFC,
43 0xFC, 0xFC, 0xFF, 0xFF, 0xFF, 0xFF, 0xFF, 0xFF, 0xFC, 0xFC, 0xFC, 0xFC,
44 0xFF, 0xFF, 0xFF, 0xFF, 0xFF, 0xFF, 0xFF, 0xFF, 0xFF, 0xFF, 0xFF, 0xFF,
45 0xFF, 0xFF, 0xFF, 0xFF, 0xFE, 0xFE, 0xFC, 0xFC, 0xFC, 0xFC, 0xFC, 0xFC,
46 0xFC, 0xFC, 0xFC, 0xFE, 0xFE, 0xFE, 0xFF, 0xFF, 0xFF, 0xFF, 0xFF, 0xFF,
47 0xFF, 0xFE, 0xFD, 0xF8, 0xF8, 0xF8, 0xF8, 0xF8, 0xF8, 0xF8, 0xF8, 0xF8,
48 0xF0, 0xF8, 0xF8, 0xFC, 0xFD, 0xFE, 0xFF, 0xFF, 0xFF, 0xFF, 0xFF, 0xFF,
49 0xFC, 0xFC, 0xFC, 0xFC, 0xFC, 0xFF, 0xFF, 0xFF, 0xFF, 0xFF, 0xFF, 0xFF,
50 0xFF, 0xFF, 0xFF, 0xFC, 0xFC, 0xFC, 0xFC
51 };
52 };
53
```



Power Consumption

CR2032 Lithium coin cell : 3V @ 225mAh to 2V

- Idle (Wait) = 0.7mA
- Active (LCD update) = 8.3mA @ 930mS
- Serial port TX = 6.7mA

Idle mode only = 13.4 days

Typical daily use: 1H active, 23H idle = 9 days



Power Consumption 2

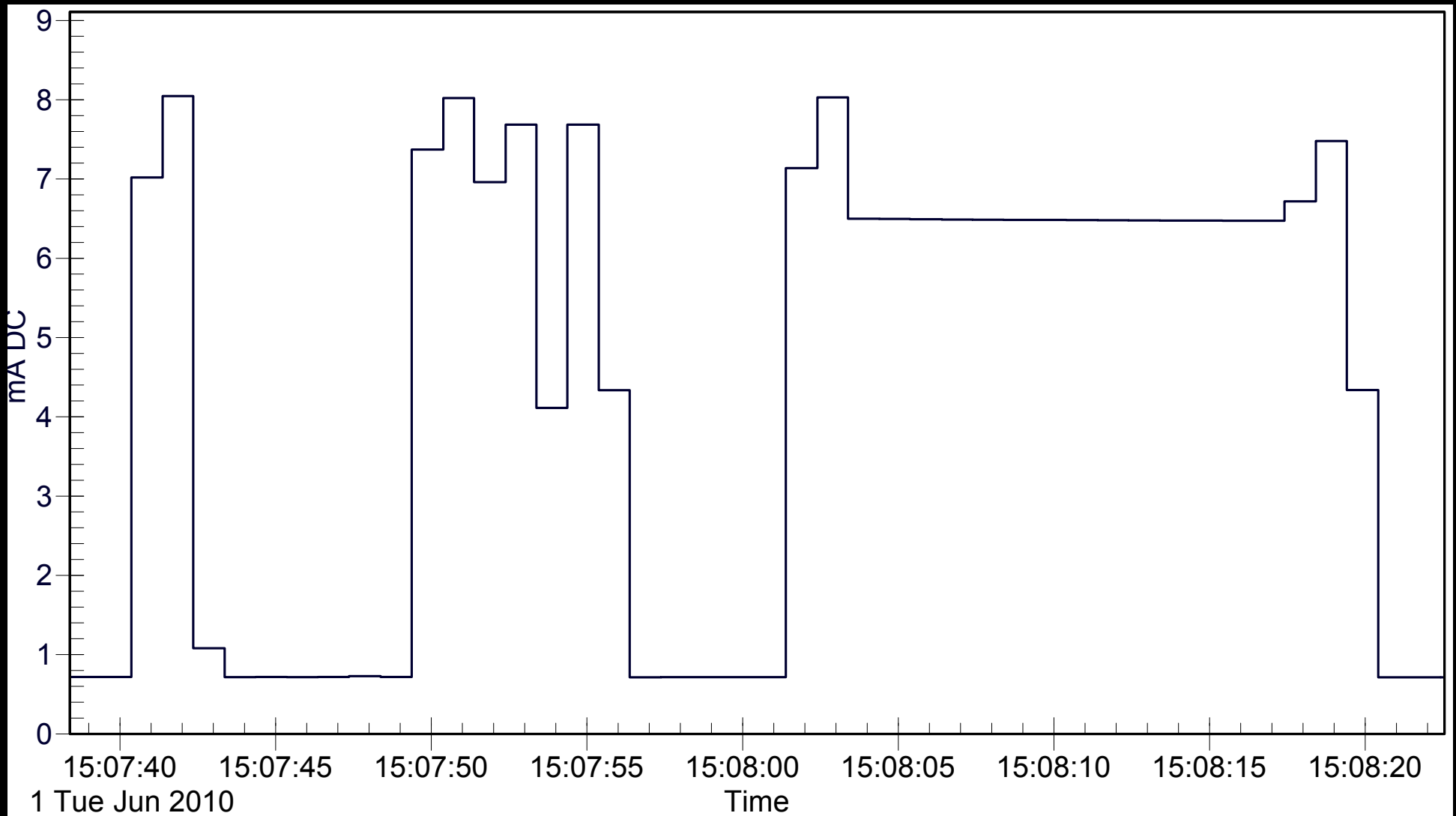

Single LCD
refresh

Multiple mode
changes

Serial port
transmitting



Seamless Power Switching

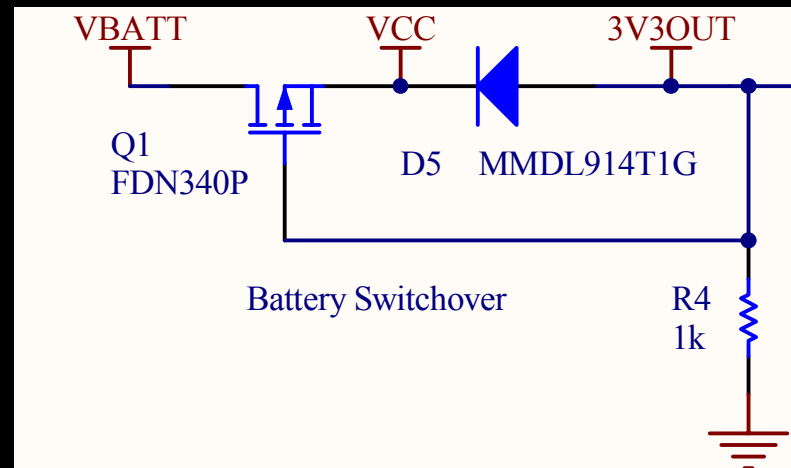

- P-channel MOSFET on by default via R4
- When USB plugged in, 3V3OUT (FT232) goes HIGH
- MOSFET turns off and battery is isolated from circuit
- Body diode of MOSFET prevents battery from getting reverse fed by 3V3OUT (small nA leakage is OK)
- Voltage drop across D5 causes VCC to be lower for USB-powered (2.7V) than battery powered (3V)
- Higher forward voltage (V_f) -> lower reverse leakage (V_r)



Seamless Power Switching 2

- Battery to USB

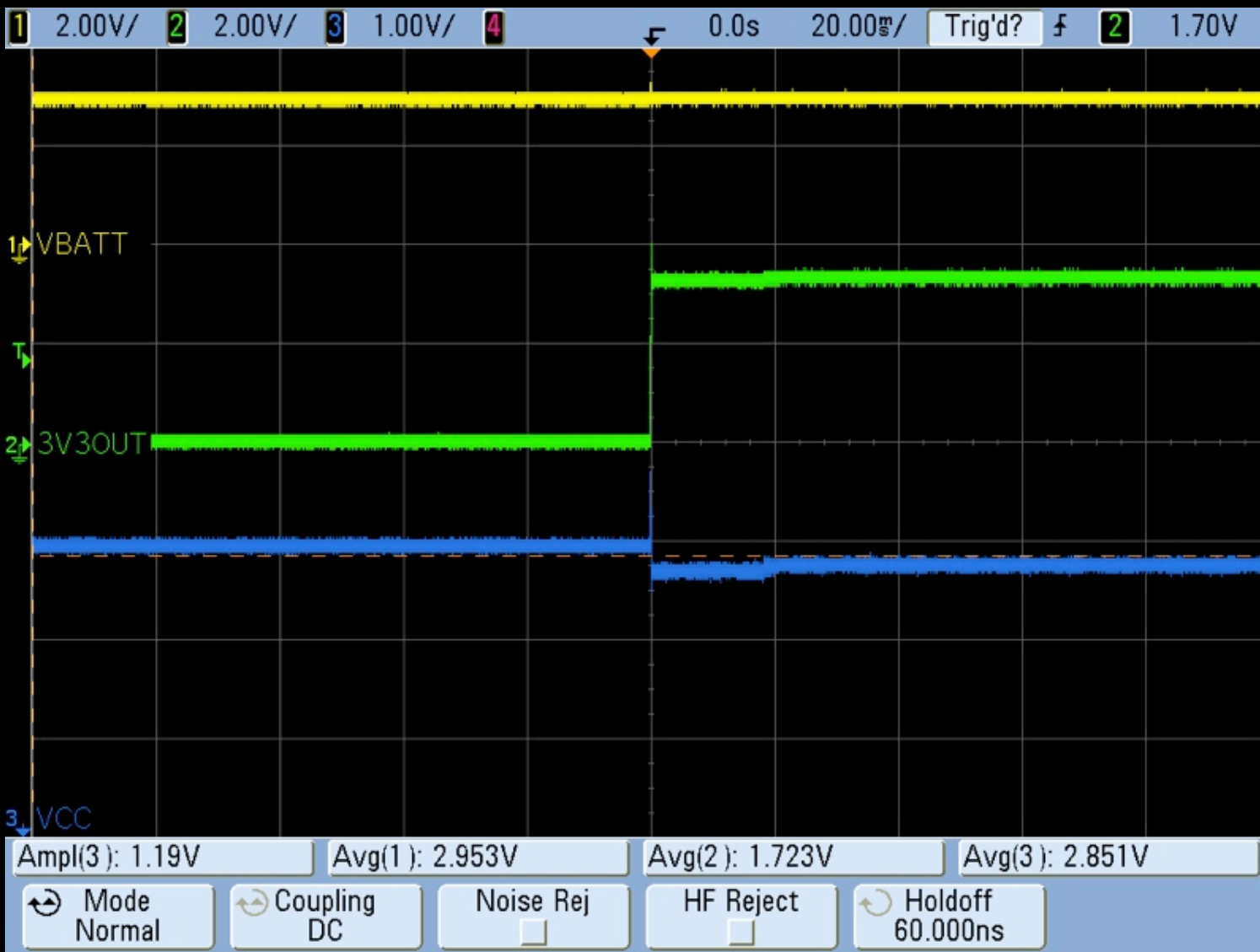

Seamless Power Switching 3

- USB to Battery

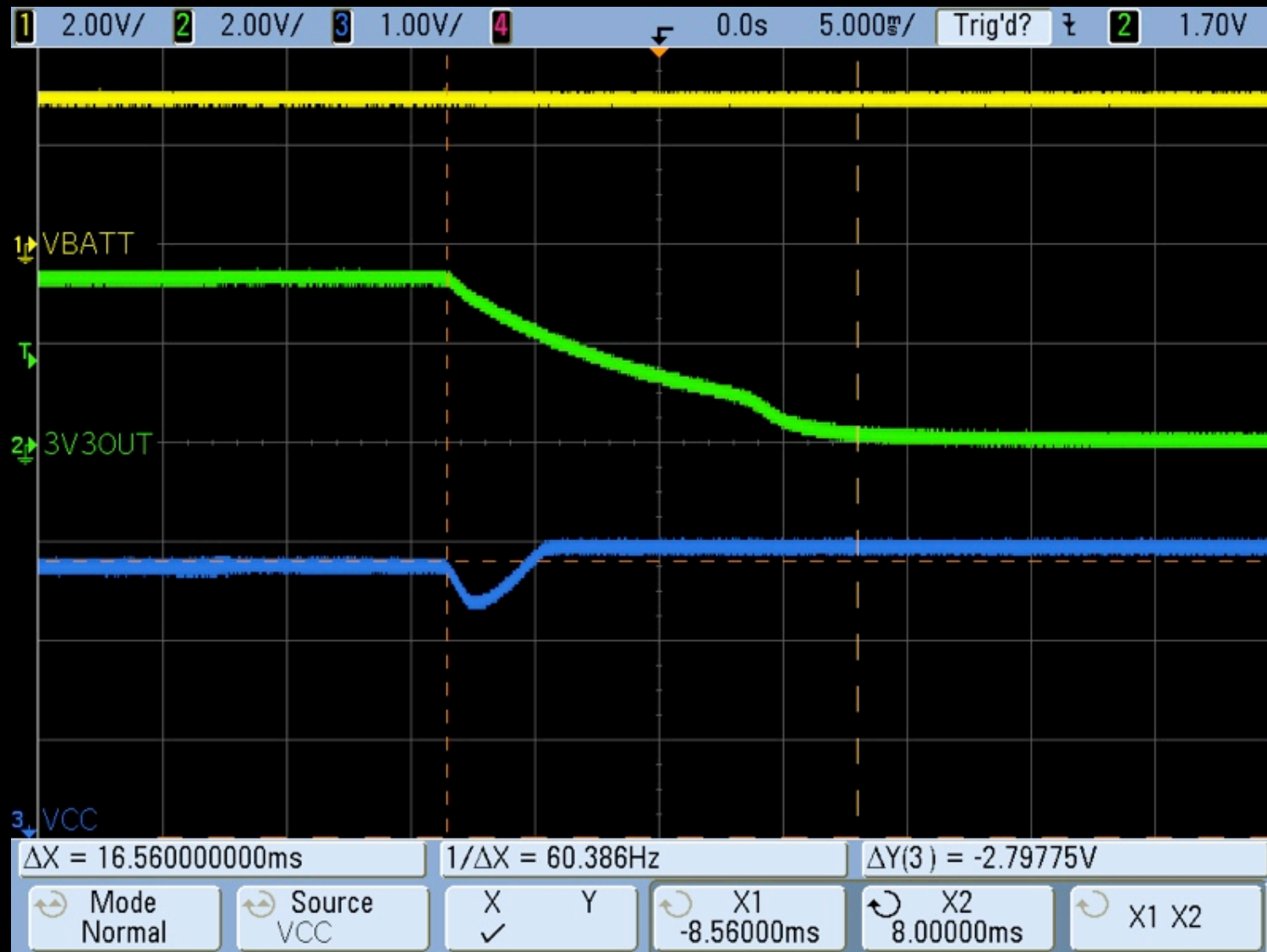

Total Badge Types

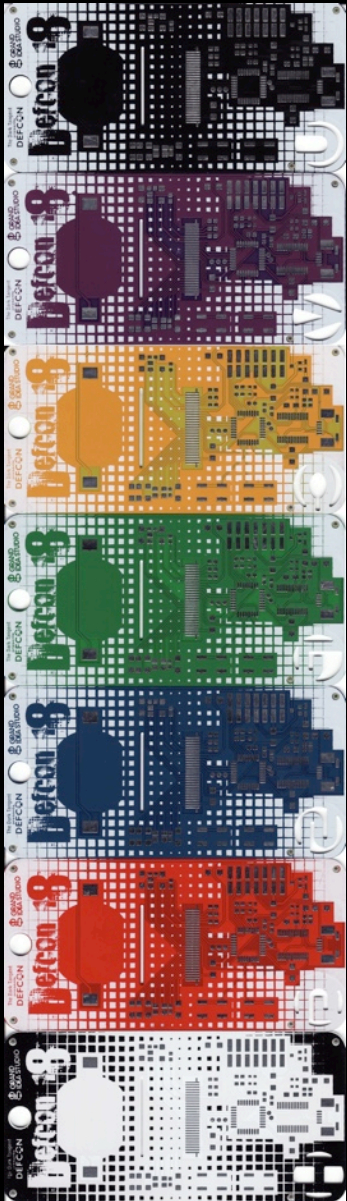

Human = 7000

Speaker = 200

Goon = 200

Press = 180

Vendor = 100

Contest = 70

Uber = 30

Total = 7780

Collect them
all!@#



Time flies, but who's counting?

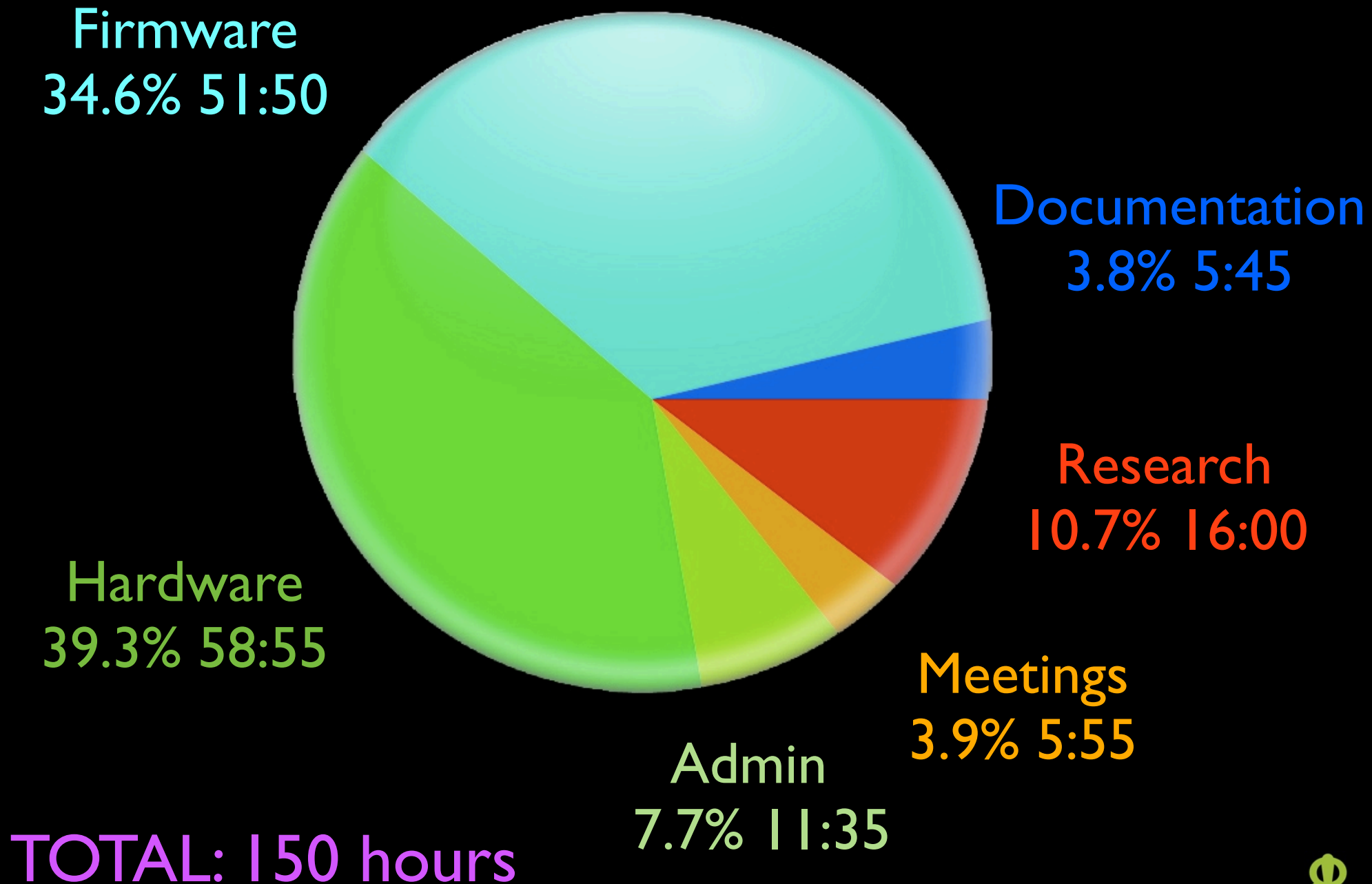

Badge Hacking Contest

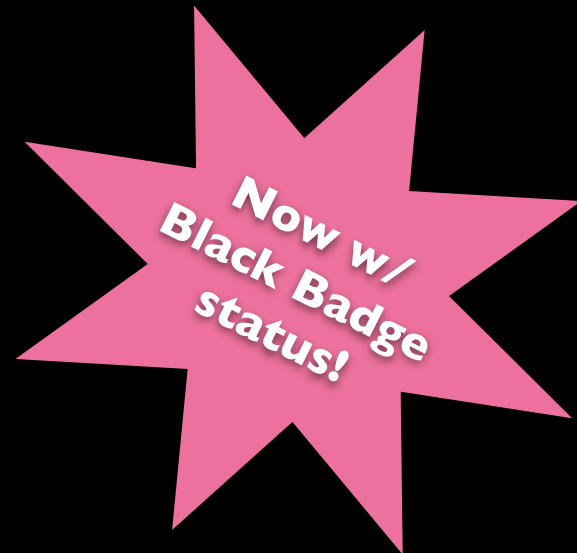

Previous results at
[www.grandideastudio.com/
portfolio/defcon-1x-badge/](http://www.grandideastudio.com/portfolio/defcon-1x-badge/)

x = 4, 5, 6, 7

Badge Hacking Contest HQ @
Hardware Hacking Village

Submit your entry to
Kingpin starting at 2pm
Sunday in the HHV

Complete schematic, source code, tools, etc. on DEFCON CD





THE END!!
JOE@GRANDIDEASTUDIO.COM